

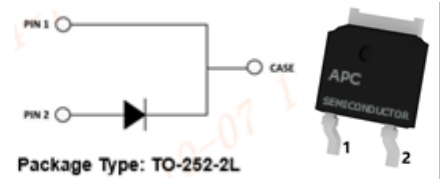

High Power SiC Schottky Barrier Diode ASA004V065F4



Applications:

- Industrial power supplies: Industrial UPS
- Battery chargers
- Solar inverters
- Switch mode power supplies

Features:

- Revolutionary semiconductor material - Silicon Carbide (SiC)
- No reverse recovery
- High-speed switching performance
- System cost / size saving due to reduced cooling requirement
- Junction Temp range -55°C to 175°C

Absolute Maximum Ratings (T_{amb}=25°C, unless specified otherwise)

Symbol	Parameter		ASA004V065F4	Unit
V _{DC}	DC reverse voltage		650	V
V _{RRM}	Repetitive peak reverse voltage			
V _{RSM}	Surge peak reverse voltage			
I _F	Continuous Forward Current	T _C = 25°C	14	A
		T _C = 135°C	7	
		T _C = 155°C	4	
I _{FSM}	Surge non-repetitive forward current	T _C = 25°C, t _p = 10ms, half sine pulse	28	
		T _C = 150°C, t _p = 10ms, half sine pulse	25	
I _{F,Max}	Non-repetitive peak forward current	T _C = 25°C, t _p = 10μs, pulse	214	
I _{FRM}	Surge repetitive forward current	T _C = 25°C, t _p = 10ms, half sine wave D = 0.1	19	
P _{tot}	Total Power Dissipation		65	W
∫i ² dt	i ² t value		3.9	A ² s
T _j	Operating junction temperature range		-55 to 175	°C
T _{stg}	Storage temperature range		-55 to 175	
M	Mounting torque	M3 screw	1	Nm

Static Electrical Characteristics ($T_A = 25^\circ\text{C}$, unless specified otherwise)

Symbol	Parameter	Test Conditions	Min	Typ	Max	Unit
V_{DC}	DC blocking voltage	$I_R = 100 \mu\text{A}$	650	-	-	V
V_F	Forward voltage	$I_F = 4\text{A}, T_j = 25^\circ\text{C}$	-	1.27	1.45	V
		$I_F = 4\text{A}, T_j = 175^\circ\text{C}$	-	1.45	1.70	
I_R	Reverse current	$V_R = 650\text{V}, T_j = 25^\circ\text{C}$	-	3	24	μA
		$V_R = 650\text{V}, T_j = 175^\circ\text{C}$	-	10	96	

Thermal Characteristics

Symbol	Parameter	Test conditions	Min	Typ	Max	Unit
$R_{\theta JC}$	Junction-to-case Thermal Resistance		-	2.30	-	$^\circ\text{C}/\text{W}$

Dynamic Characteristics ($T_A = 25^\circ\text{C}$, unless specified otherwise)

C	Total capacitance	$V_R = 0\text{V}, f = 1\text{MHz}$	-	231	-	pF
		$V_R = 200\text{V}, f = 1\text{MHz}$	-	21	-	
		$V_R = 400\text{V}, f = 1\text{MHz}$	-	17	-	
Q_C	Total capacitive charge	$V_R = 400\text{V}$	-	11	-	nC
E_C	Capacitance stored energy	$V_R = 400\text{V}$	-	1.6	-	μJ

Electrical Characteristic Diagrams

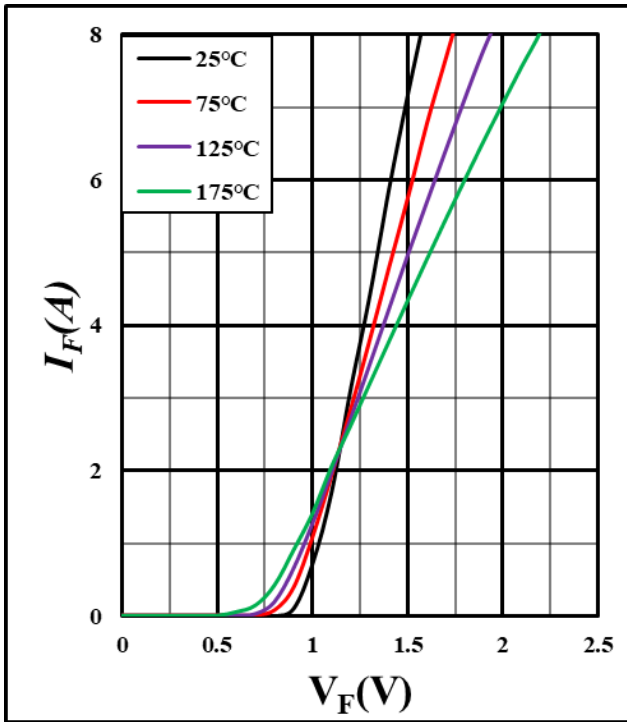

Figure 1. Forward characteristics

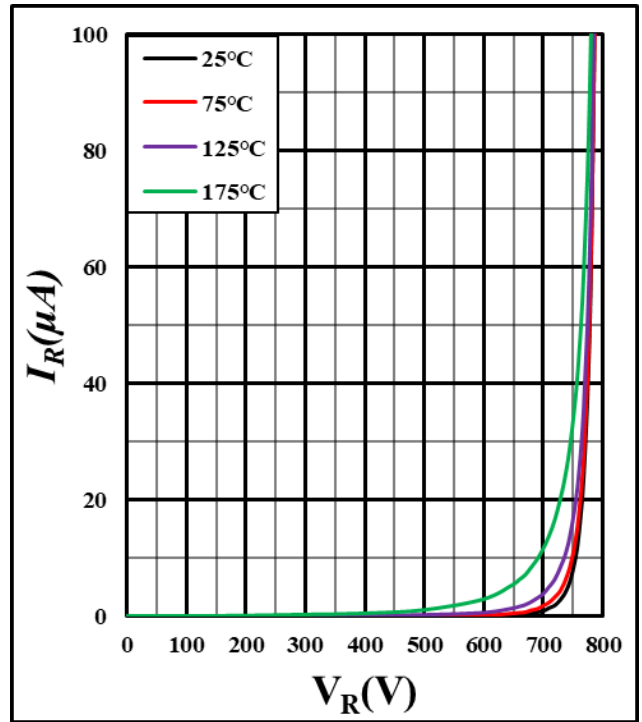

Figure 2. Reverse characteristics

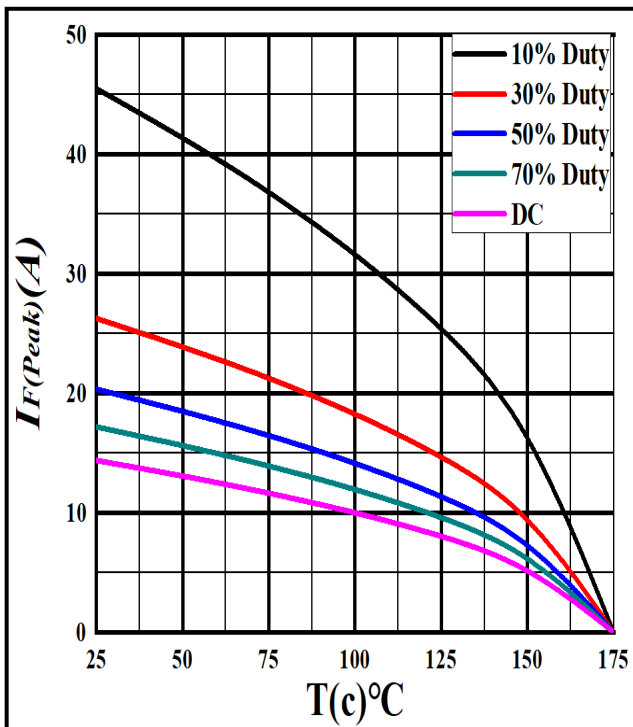

Figure 3. Current derating

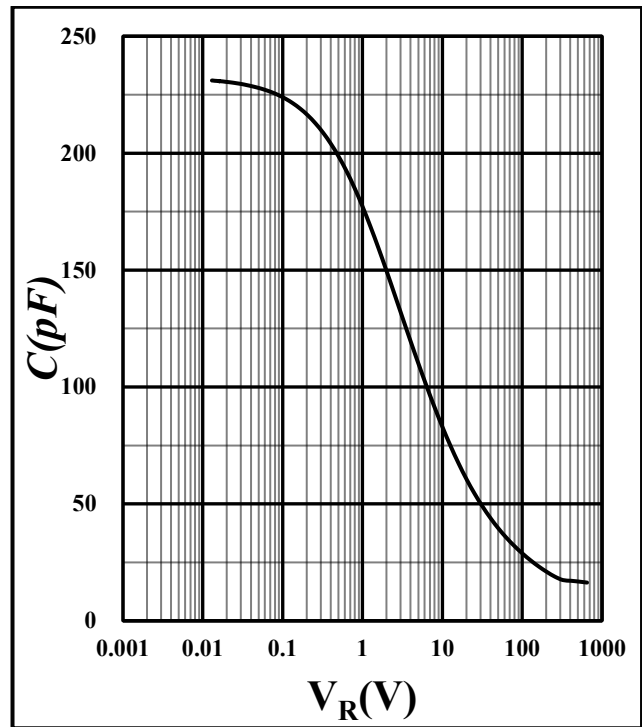

Figure 4. Capacitance vs. reverse voltage

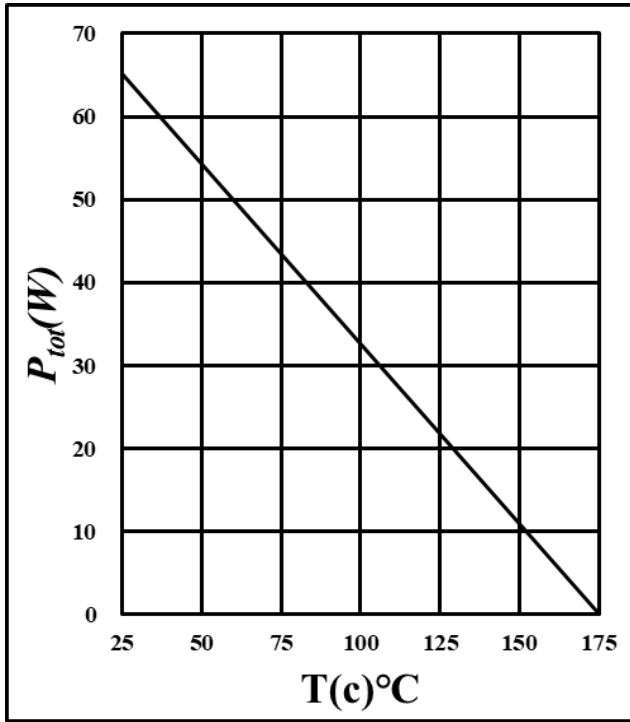

Figure 5. Power derating

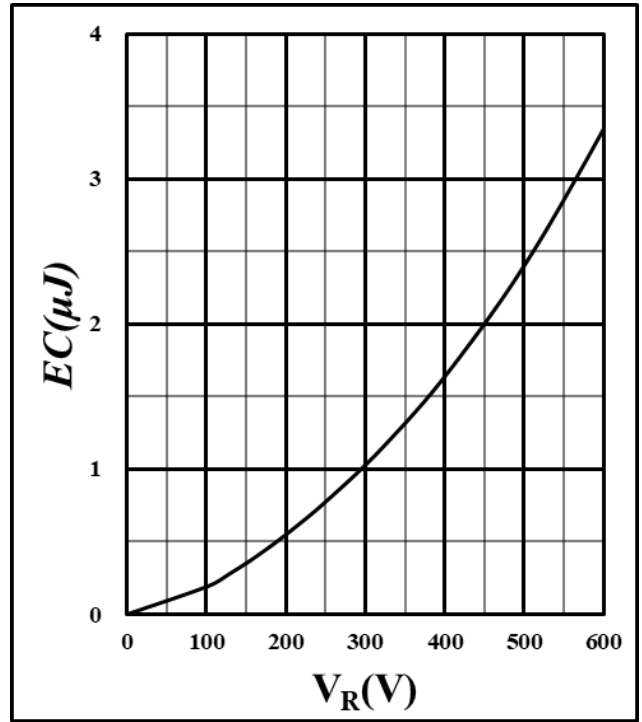

Figure 6. Capacitance stored energy

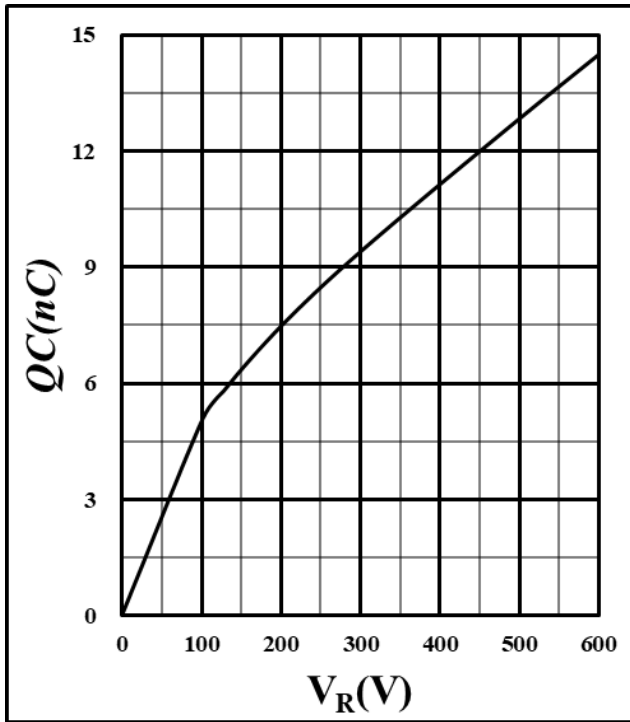

Figure 7. Total capacitance charge vs. reverse voltage

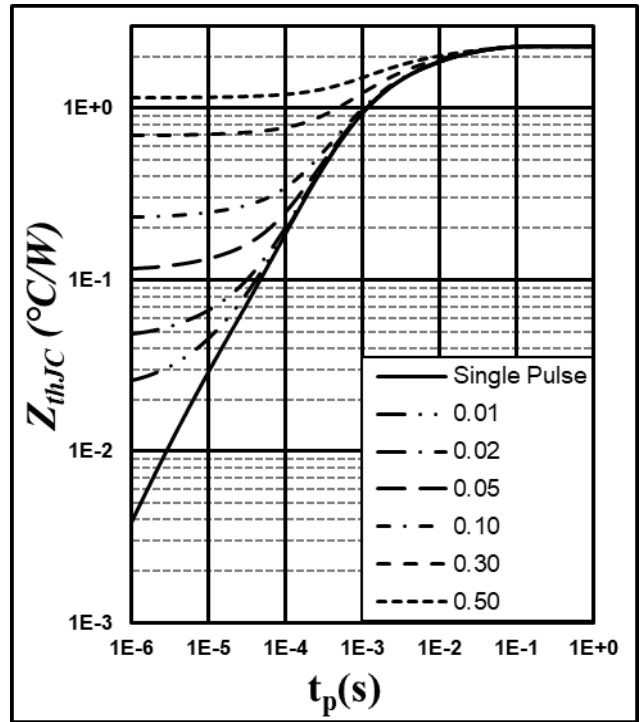
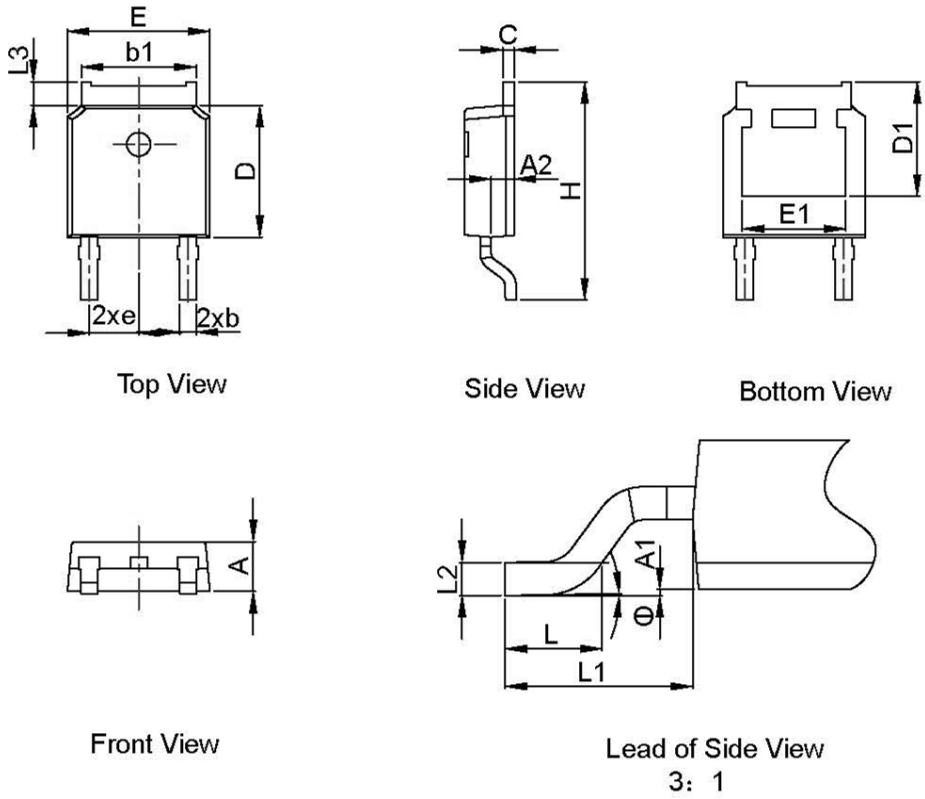

Figure 8. Transient Thermal Impedance
 (Junction - Case)

Package Information



Dimension unit: [mm]			
Symbol	Min	Nom	Max
A	2.20	2.30	2.38
A1	0	-	0.127
A2	0.97	1.07	1.17
b	0.68	0.78	0.90
b1	5.20	5.33	5.46
c	0.43	0.53	0.61
D	5.98	6.10	6.22
D1	5.30 REF		
E	6.40	6.60	6.73
E1	4.63	-	-
e	2.286 BSC		
H	9.40	10.10	10.50
L	1.38	1.50	1.75
L1	2.743 REF		
L2	0.51 BSC		
L3	0.88	-	1.28
θ	0°	-	8°

Recommended Solder Pad Layout

Note: All dimensions are in mm

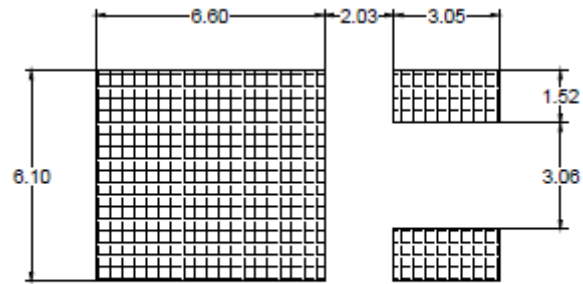

TO-252-2L

Ordering Information

Part number	ASA004V065F4
Package	TO-252-2L
Unit quantity	2500 EA
Packing type	Tape & Reel

For more information, visit <https://www.apowerc2.com>