

CBM-40

Sky Blue Chip On Board LEDs

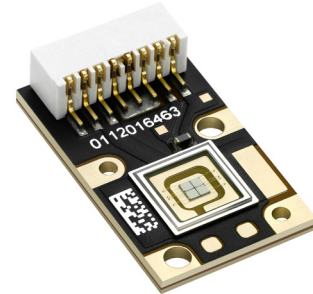

Table of Contents

Technology Overview2

Ordering Information3

Binning Structure4

Ordering Bin Kits5

Optical & Electrical Characteristics6

Typical Spectrum8

Angular Distribution8

Thermal Resistance9

Electrical Pinout.....9

Mechanical Dimensions Square Package 10

Shipping Tray 11

Packaging Specifications . 12

Revision History..... 13

Features:

- High-power LED with surface emitting area of 3.84 mm² and 1:1 aspect ratio
- Sky Blue color with emission at 470nm typical peak wavelength
- Typical radiometric power output of 5.5W at 6A (standard test condition)
- All the benefits of chip on board processing without the need for complicated assembly process
- Vertical chip Blue LED technology for high power density and uniform emission
- High thermal conductivity copper coreboard package (common cathode)
- Low-profile window for efficient coupling into small-etendue systems
- Can be operated at variable drive currents up to 6A
- Environmentally friendly: RoHS and Halogen compliant

Applications:

- Machine Vision
- Fiber-coupled illumination
- Microscopy and Fluorescence Applications
- Medical and Scientific Instrumentation

Technology Overview

Luminus LEDs benefit from innovations in device technology, chip packaging and thermal management. This suite of technologies give engineers and system designers the freedom to develop solutions both high in power and efficiency.

Luminus LED Technology

Luminus Devices vertical chip technology enables LED chips with uniform brightness over the entire chip surface. The optical power and brightness produced by these densely packed arrays of devices enable solutions not possible with single chip packages that be used to replace arc and halogen lamps.

Packaging Technology

Thermal management is critical in high power LED applications. With a thermal resistance from junction to board of 1.15 °C/W, Luminus CBM-40 LEDs exhibit very low thermal resistance. This will allow the LEDs to be driven at higher current densities while maintaining a low junction temperature, thereby resulting in brighter solutions and longer lifetimes.

Environmental Benefits

Luminus LEDs help reduce power consumption and the amount of hazardous waste entering the environment. All LED products manufactured by Luminus are RoHS and Halogen compliant and free of hazardous materials, including lead and mercury.

Reliability

With designs based on years of chip and packaging development experience, Luminus LEDs are one of the most reliable light sources in the world today. Luminus LEDs pass a rigorous suite of environmental and mechanical stress tests, including mechanical shock, vibration, temperature cycling and humidity, and have been fully qualified for use in extreme high power and high current applications. With very low failure rates and median lifetimes that can exceed 30,000 hours, Luminus LEDs are ready for even the most demanding applications.

Static Electricity

Luminus CBM-40-SB LEDs are sensitive to static electricity, and care should be taken when handling them. Static electricity or surge voltage will damage the LEDs. It is recommended to wear an anti-electrostatic wristband or anti-electrostatic gloves when handling the LEDs. All devices, equipment and machinery must be properly grounded. It is recommended that measures be taken to isolate LED processing equipment from potential sources of voltage surges.

Reference: APN-002815 "Electrical Stress Damage to LEDs and How to Prevent It".

Understanding CBM-40-SB LED Test Specifications

Every Luminus LED is fully tested to ensure that it meets the high quality standards expected from Luminus products.

Testing Temperature

Luminus core board products are typically measured in such a way that the characteristics reported agree with how the devices will actually perform when incorporated into a system. This measurement is accomplished by mounting the devices on a 40°C heat sink and measuring the device while fully powered.

This method of measurement ensures that Luminus LEDs perform in the field just as they are specified.

Multiple Operating Points

The tables on the following pages provide typical optical and electrical characteristics for the standard drive conditions. Since the LEDs can be operated over a wide range of drive conditions (currents from 200 mA to 6 A, and duty cycle from <1% to 100%) there are many other potential values attainable. Driving devices beyond recommended driving conditions shortens lifetime.

Ordering Information

Product	Ordering Part Number	Description
CBM-40-SB	CBM-40-SB-C32-FF###-##	CBM-40 Sky Blue chipset consisting of 4x1 mm ² Sky Blue (470nm) LEDs, a thermistor, connectors and a copper-core PCB.

Part Number Nomenclature

CBM — 40 — DC — C## — FF###-##

Product Family	Chip Area	Color	Package Configuration	Bin Kit ^{1,2}
CBM: Copper-core PCB, Array	40: 4 mm ² class	SB: Sky Blue	C32: 26.5 mm x 16.0 mm	See page 5 for complete bin definition table

Note 1: A Bin Kit represents a group of individual flux or power bins that are shippable for a given ordering part number. Individual flux bins are not orderable.

Note 2: Flux Bin listed is minimum bin shipped - higher bins may be included at Luminus discretion.

CBM-40-SB Binning Structure

CBM-40-SB LEDs are specified for radiometric flux and chromaticity/wavelength at a drive current of 6 A (1.5 A/mm²) and placed into one of the following Power Bins and Wavelength Bins:

Power Bins³

Color	Power Flux Bin (FF)	Minimum Flux (W)	Maximum Flux (W)
SB	DC	4.7	5.0
	EA	5.0	5.5
	EB	5.5	6.0
	FA	6.0	6.5

Note 3: Luminus maintains a +/- 6% tolerance on power measurements.

Peak Wavelength Bins

Color	Wavelength Bin (###)	Minimum Wavelength (nm)	Maximum Wavelength (nm)
SB	460	460	465
	465	465	470
	470	470	475
	475	475	480

CBM-40-SB Bin Kits

Wavelength Range	Radiometric Flux		Wavelength Bins	Ordering Bin Kit Number
	Bin Kit Flux Code	Min. Flux (W)		
460-480	DC	4.7	460, 465, 470, 475	DC460

Reference Optical & Electrical Characteristics ($T_{hs} = 40^{\circ}\text{C}$)^{4,5}

SB			
Parameter	Symbol	Values ⁶	Unit
Peak Wavelength Range	λ	460-480	nm
Drive Conditions ⁷	I	6.0	A
Peak Wavelength Typ.	λ_p	467	nm
Forward Voltage	V_{Fmin}	2.5	V
	V_F	3.3	V
	V_{Fmax}	4.0	V
Radiometric Flux ⁸	Φ_{typ}	5.5	W
FWHM at 50% of Φ	$\Delta\lambda_{1/2}$	26	nm

Parameter	Symbol	Values	Unit
Absolute Minimum Current (CW or Pulsed) ⁹		0.2	A
Absolute Maximum Current (CW) ¹⁰		6	A
Absolute Maximum Surge Current ¹⁰ (Frequency > 240 Hz, duty cycle =10%, t=1ms)		8	A
Maximum Junction Temperature ¹¹	T_{jmax}	115	$^{\circ}\text{C}$
Storage Temperature Range		-40 to +100	$^{\circ}\text{C}$
Emitting Area		3.84	mm^2
Emitting Area Dimensions		1.96 x 1.96	$\text{mm} \times \text{mm}$

Note 4: Data verified using NIST traceable calibration standard.

Note 5: All data are based on test conditions with a constant heat sink temperature $T_{hs} = 40^{\circ}\text{C}$ under pulse testing conditions. Single pulse conditions: 20 ms pulse length, 3 second soak.

Note 6: Unless otherwise noted, values listed are typical. Devices are production tested and specified at 6 A.

Note 7: Listed drive conditions are typical for common applications. CBM-40-SB devices can be driven at CW currents ranging from 200 mA to 6 A and at duty cycles ranging from 1% to 100%. Drive current and duty cycle should be adjusted as necessary to maintain the junction temperature desired to meet application lifetime requirements.

Note 8: Typical total flux from emitting area at listed peak wavelength. Reported performance is included to show trends for a selected power level. For specific minimum and maximum values, use bin tables. For product roadmap and future performance of devices, contact Luminus.

Note 9: Special design considerations must be observed for operation under 1 A. Please contact Luminus for further information.

Note 10: CBM-40-SB LEDs are designed for operation to an absolute maximum current as specified above. Product lifetime data is specified at recommended forward drive currents. Sustained operation at or beyond absolute maximum currents will result in a reduction of device life time compared to recommended forward drive currents. Actual device lifetimes will also depend on junction temperature.

Note 11: Lifetime dependent on LED junction temperature. Input power and thermal system must be properly managed to ensure lifetime.

Optical & Electrical Characteristics

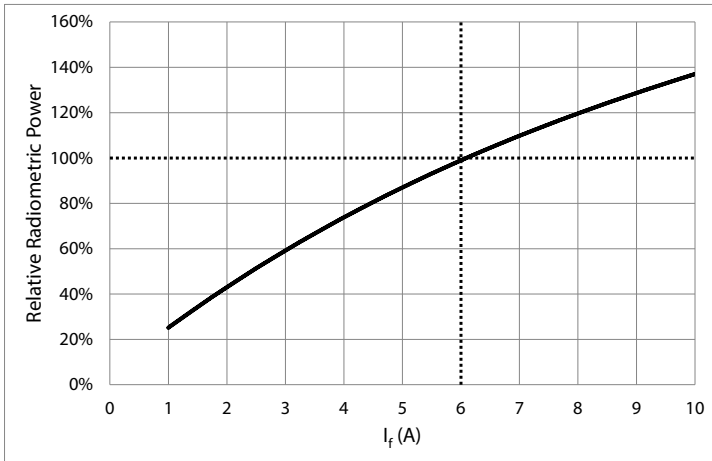
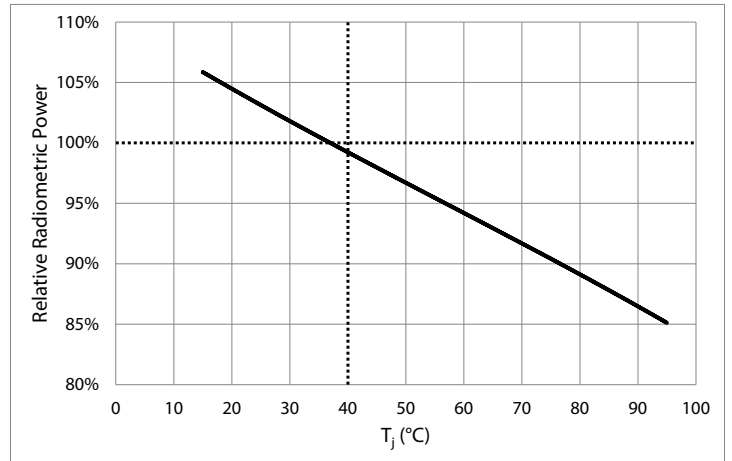
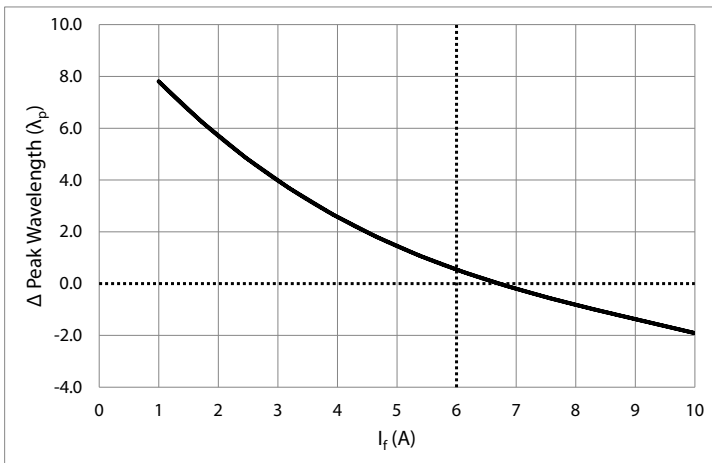
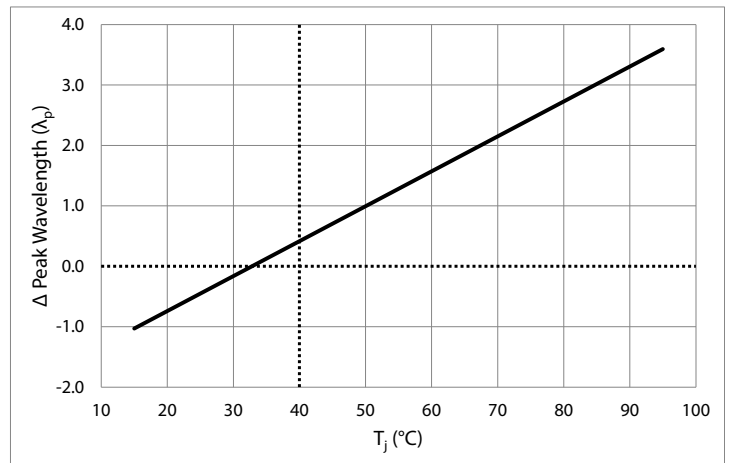
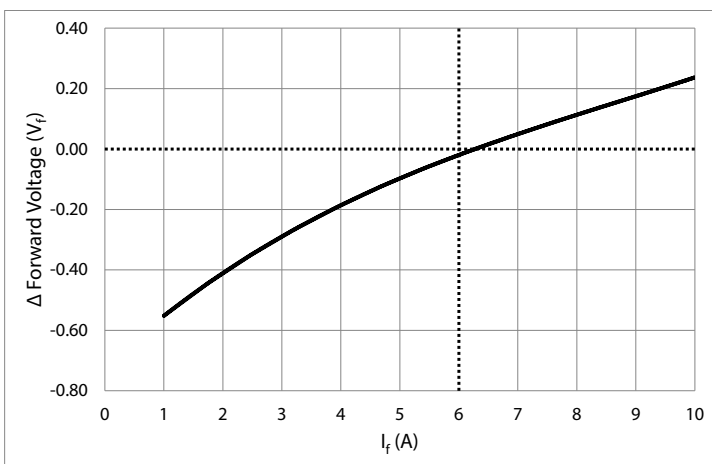
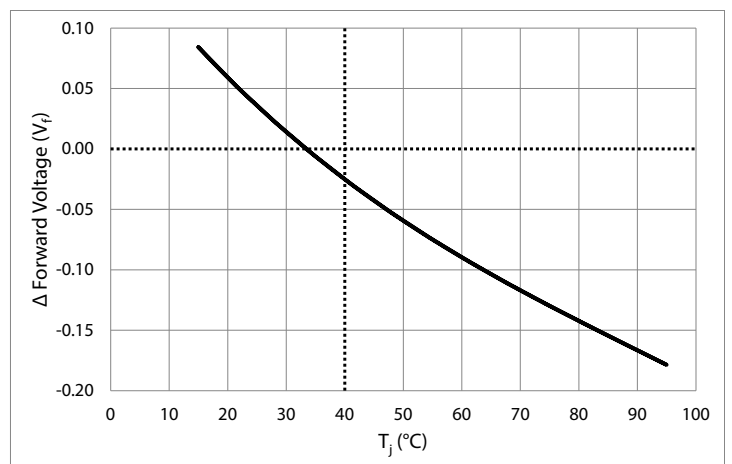
Relative Power vs Forward Current, $T_{HS} = 40^{\circ}\text{C}$

Relative Power vs Junction Temperature

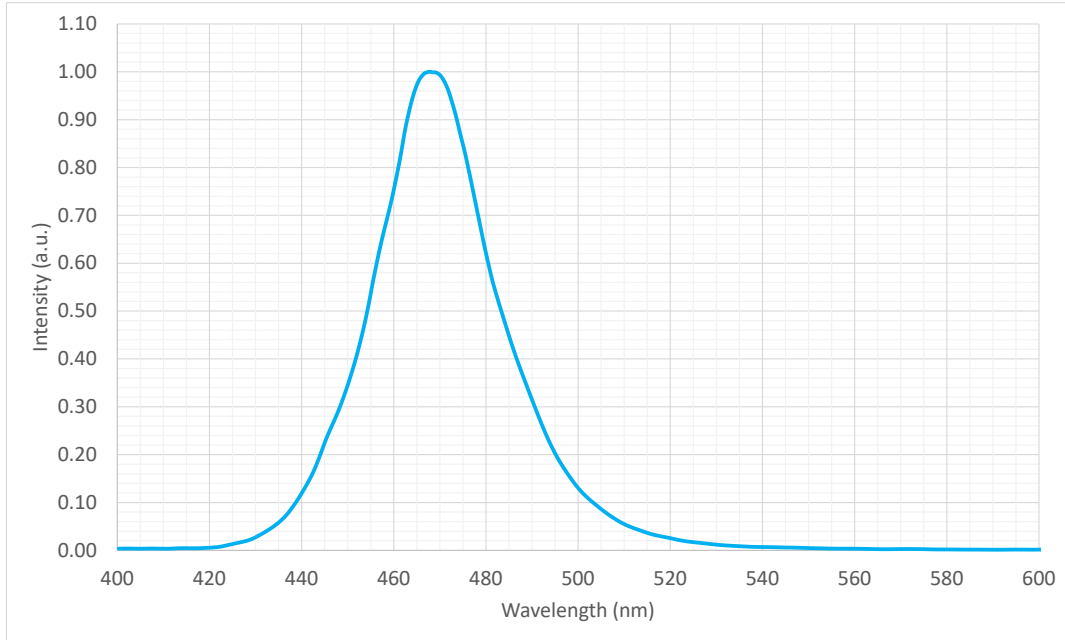
Relative Peak Wavelength vs Forward Current

Rel. Peak Wavelength vs Junction Temperature

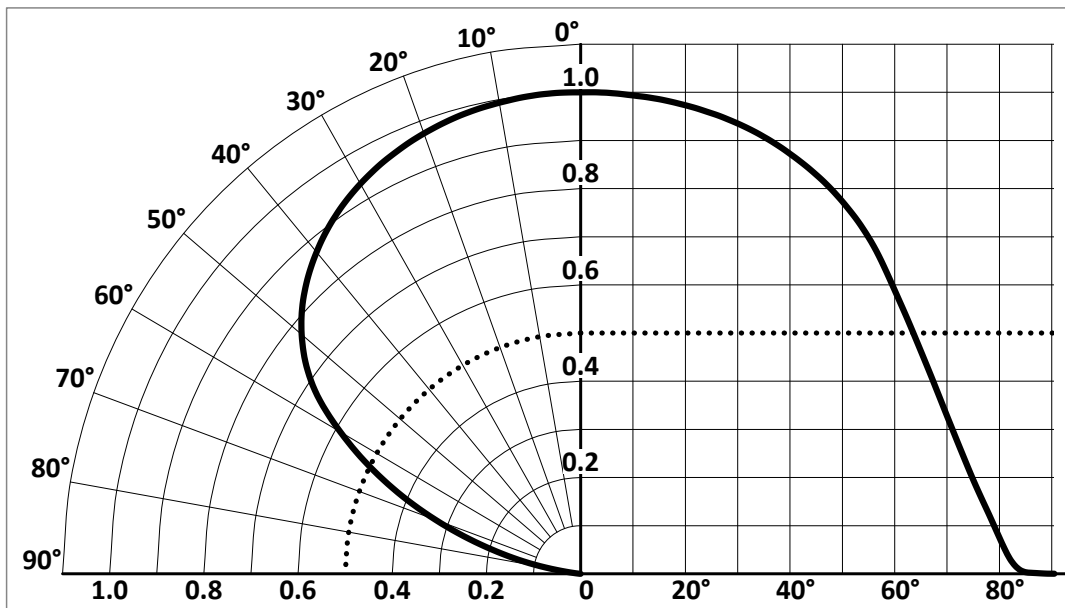
Relative Forward Voltage vs Forward Current

Rel. Forward Voltage vs Junction Temperature

Typical Spectrum¹²



Angular Distribution^{12,13}



Note 12: Typical spectrum at current of 6 A in continuous operation and at 40°C heat sink temperature.

Note 13: Detailed information on emission including ray trace files can be found at: <http://www.luminus.com>

Thermal Resistance CBM-40-SB

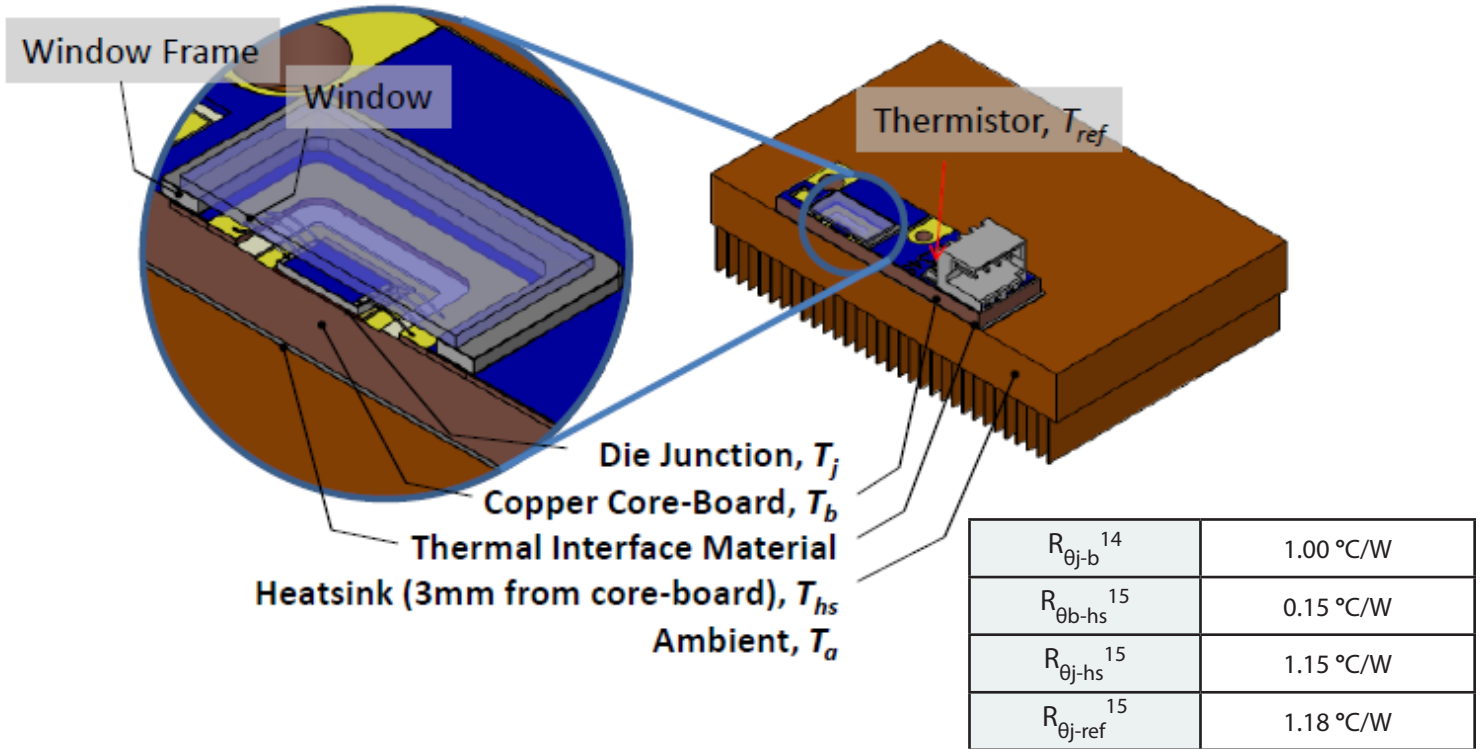

Note 14: Real thermal resistance data - "Electrical" thermal resistance values available upon request

Note 15: Thermal Resistance is based on eGraf 1205 Thermal interface.

Thermistor Information

The thermistor used in CBM-40 devices is NCP18XH103J03RB. Please see <http://www.murata.com/> for details on calculating thermistor temperature.

For more information on use of the thermistor, please contact Luminus directly at techsupport@luminus.com.

Mechanical Dimensions – CBM-40-SB LED

DIMENSIONS IN MILLIMETERS

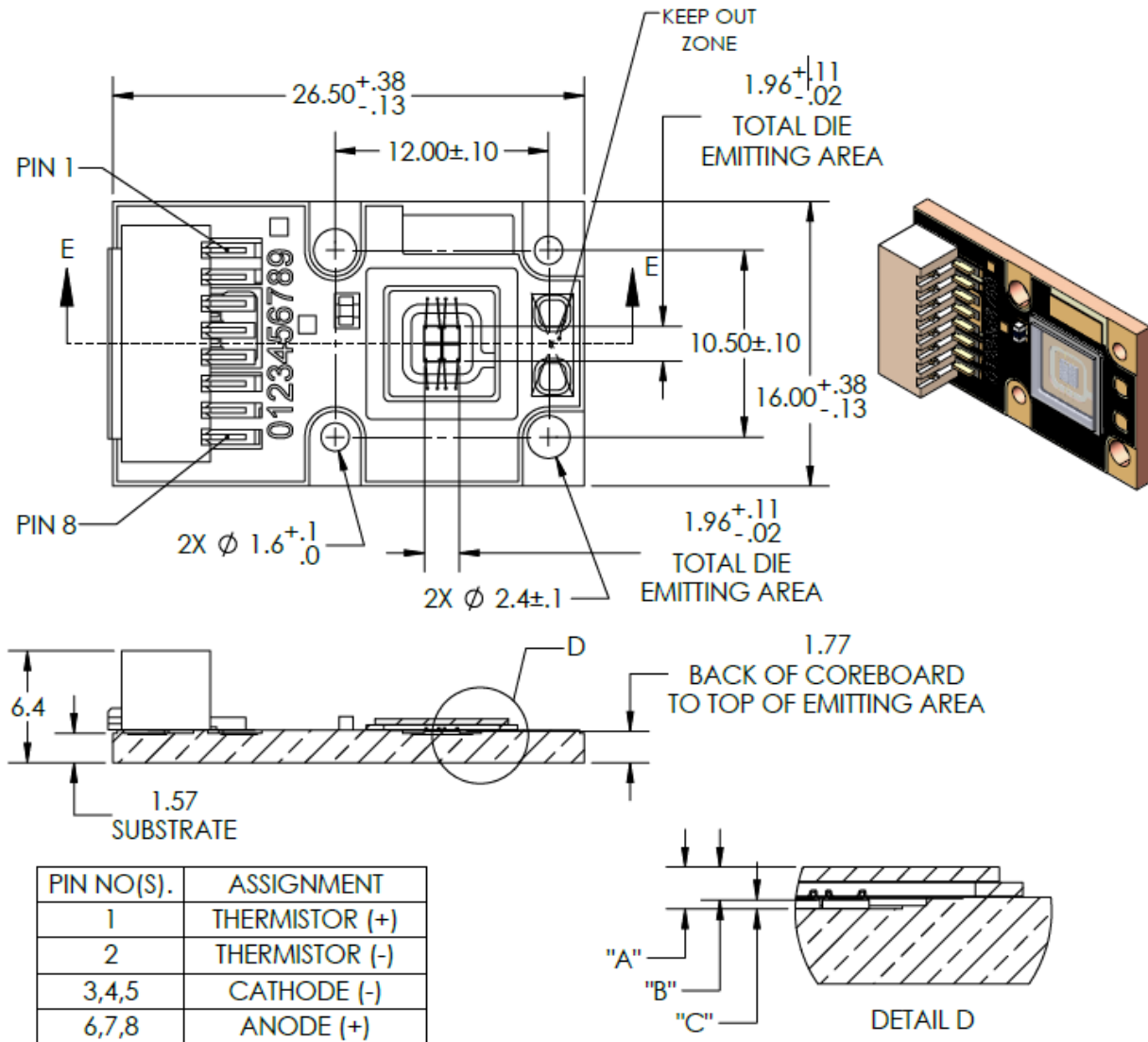

DIMENSION NAME	DESCRIPTION	NOMINAL DIMENSION	TOLERANCE
"A"	TOP OF METAL SUBSTRATE TO TOP OF WINDOW	.88	±.13
"B"	TOP OF EMITTING AREA TO TOP OF WINDOW	.69	±.11
"C"	TOP OF METAL SUBSTRATE TO TOP OF EMITTING AREA	.19	±.02

Mating Connector Information:

- Connector Manufacturer: Tarnng-Yu: Part # TU1512HNO-08-M5
- Mating Connector Cable Assembly ordering part number (small quantity orders for evaluation purposes only): **960041**

Shipping Tray Outline - CBM-40-SB

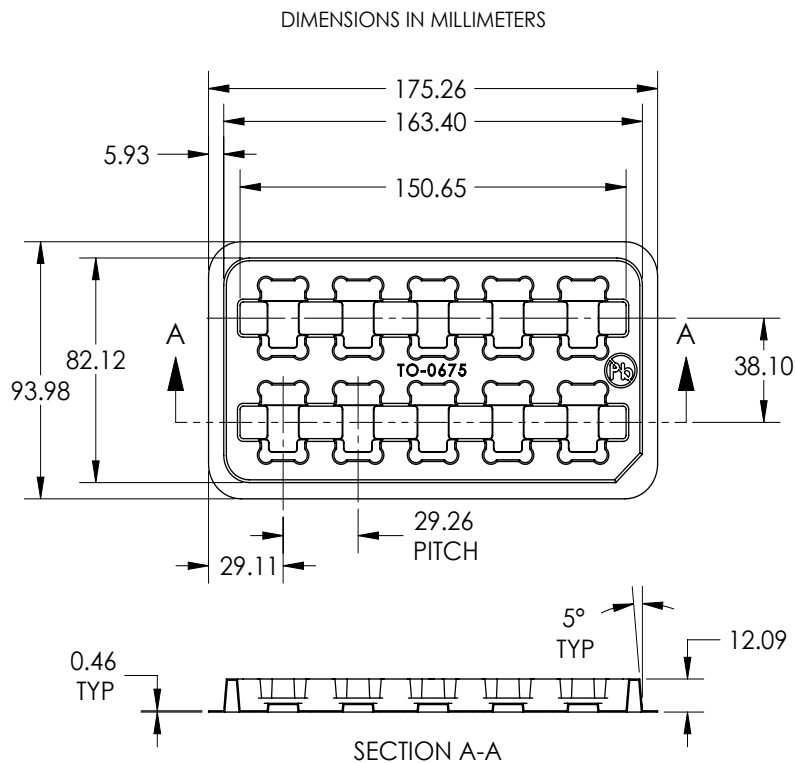

TOP TRAY SHOWN TRANSPARENT
FOR REFERENCE ONLY

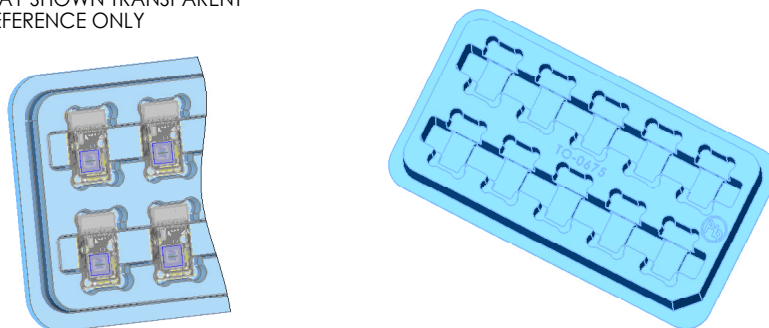

Packing and Shipping Specification (CBM-40)

Packing Specification

Packing Configuration	Qty /Pack	Box Dimensions (diameter x W, mm)	Gross Weight (kg)
Stack of 5 trays with 10 devices per tray Each pack is enclosed in ESD bag	50	95 x 176 x 50	0.45

Product Label Specification

Label Fields (subject to change):

- 6-8 digit Box number (for Luminus internal use)
- Luminus ordering part number
- Quantity of devices in pack
- Part number revision (for Luminus internal use)
- Customer's part number (optional)
- Flux Bin
- 2D Bar code





BP-012345

 Box number

PT-39-G-L21-MPH

 Luminus part number

12345678

 Customer part number

2J

 Bin

Qty: 50

Rev 01



for traceability peel off label and attach

RoHS Compliant

Sample label –for illustration only

Shipping Box

Shipping Box	Quantity	Material	Dimensions (L x W x H, mm)
Carton Box	1 -20 packs	S4651	560 x 560 x 200

History of Changes

Rev	Date	Description of Change
01	05/09/2021	Initial release to production

The products, their specifications and other information appearing in this document are subject to change by Luminus Devices without notice. Luminus Devices assumes no liability for errors that may appear in this document, and no liability otherwise arising from the application or use of the product or information contained herein. None of the information provided herein should be considered to be a representation of the fitness or suitability of the product for any particular application or as any other form of warranty. Luminus Devices' product warranties are limited to only such warranties as accompany a purchase contract or purchase order for such products. Nothing herein is to be construed as constituting an additional warranty. No information contained in this publication may be considered as a waiver by Luminus Devices of any intellectual property rights that Luminus Devices may have in such information. Big Chip LEDs™ is a registered trademark of Luminus Devices, Inc., all rights reserved.

This product is protected by U.S. Patents 6,831,302; 7,074,631; 7,083,993; 7,084,434; 7,098,589; 7,105,861; 7,138,666; 7,166,870; 7,166,871; 7,170,100; 7,196,354; 7,211,831; 7,262,550; 7,274,043; 7,301,271; 7,341,880; 7,344,903; 7,345,416; 7,348,603; 7,388,233; 7,391,059 Patents Pending in the U.S. and other countries.