

# CFT-50X-B

## Blue LED

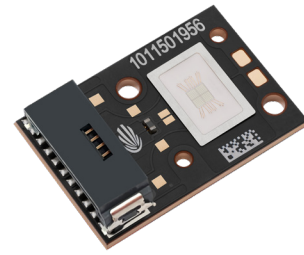

### Features

- Monolithic electrically isolated Blue LED with 5 mm<sup>2</sup> emitting area for optimal coupling into 2-4 mm diameter fiber bundles
- Typical peak wavelength emission of 460 nm
- Comprehensive product line spanning the entire visible range in the same package platform
- High drive current operation: up to 10 A under CW conditions and 12.5 A under pulse conditions
- Windowless package improves coupling-efficiency into fiber optics
- Excellent peak wavelength stability with current and temperature across the spectrum
- Compatible with high voltage / low current operation



### Applications

- Fiber-coupled Illumination
- Life-science/ Biomedical
- Fluorescence microscopy
- Machine Vision
- Industrial Lighting
- Light engines

### Table of Contents

Ordering Information. . . . .	2
Binning Structure. . . . .	3
Absolute Maximum Ratings . . . . .	4
Device Characteristics . . . . .	5
Angular Distribution and Typical Spectrum. . . . .	8
Mechanical Dimensions. . . . .	9
Shipping Tray Outline . . . . .	10
Shipping Label . . . . .	11
Notes . . . . .	12
Revision History . . . . .	13



## Ordering Information

### Ordering Part Numbers<sup>1</sup>

Color	Radiometric flux		Wavelength Bins	Ordering Part Number
	Min. Power Bin	Min. Power		
Blue	P	13.0 W	455, 460	CFT-50X-B-L42-P100

### Part Number Nomenclature

CFT	50X	B	L42	<Bin kit>
Product Family	Chip Area	Color	Package Configuration	Bin Kit
CFT: Copper-core PCB, no encapsulation	50X: 5.0 mm <sup>2</sup>	B: Blue	Internal package code	Refer to ordering part numbers in this document

#### Note

1. Flux Bin listed is minimum bin shipped, higher bins may be included at Luminus' discretion.



## Binning Structure

### Flux Bins<sup>1,2</sup>

Color	Radiometric Flux Bin <sup>3</sup>	Binning @ 7.5 A, T <sub>c</sub> = 25°C <sup>4</sup>	
		Minimum Power (W)	Maximum Power (W)
Blue	P	13	14
	Q	14	15
	R	15	16
	S	16	17.5

### Peak Wavelength Bins<sup>2</sup>

Color	Wavelength Bin <sup>3</sup>	Binning @ 7.5 A, T <sub>c</sub> = 25°C <sup>4</sup>	
		Minimum Wavelength (nm)	Maximum Wavelength (nm)
Blue	455	455	460
	460	460	465

**Note:**

1. Luminus maintains a +/- 6% tolerance on flux measurements.
2. Products are production tested then sorted and packed by bin.
3. Individual bins are not orderable. Please refer to the Product Ordering information page for a list of orderable bin kits.
4. Product test condition: 7.5 A, 20 ms single pulse, 25°C case temperature.



## Absolute Maximum Ratings

	Symbol	Values	Unit
Minimum Forward Current (CW or Pulsed) <sup>1</sup>	$I_{f \min}$	0.1	A
Maximum Forward Current (CW) <sup>2</sup>	$I_{f \text{ CW max}}$	10	
Maximum Forward Current (Pulsed) <sup>2</sup> (duty cycle < 50%)	$I_{f \text{ Pulsed max}}$	12.5	
Forward Surge Current (Pulsed) <sup>2</sup> (Frequency >240Hz, duty cycle <10%, t=1ms)	$I_{\text{surge max}}$	15	A
Storage Temperature		100	°C
Junction Temperature <sup>2</sup>	$T_{j \max}$	150	°C

**Note:**

1. For reference only.
2. CFT-50X-B LED is designed for operation at current up to 10 A under CW conditions, 12.5 A under pulse conditions and temperature as specified above. Product lifetime data is specified at recommended forward drive currents. Sustained operation at or beyond absolute maximum currents or temperatures will result in a reduction of device life time compared to recommended conditions. Refer to the lifetime derating curves for further information.



## Device Characteristics<sup>1,2,3</sup>

Optical and Electrical Characteristics	Symbol	Value	Unit
Emitting Area	$A_E$	4.91	mm <sup>2</sup>
Emitting Area Dimension		2.215 x 2.215	mm x mm
Test Peak Drive Current	$I_f$	7.5	A
Peak Luminous Flux <sup>4,5,6</sup>	$\Phi_V$	800	lm
Peak Radiometric Flux <sup>4,5,6</sup>	$\Phi_E$	15	W
Forward Voltage	$V_{f\ min}$	6.4	V
	$V_f$	7.2	
	$V_{f\ max}$	8.0	
Dominant Wavelength <sup>4</sup>	$\lambda_d$	465	nm
Peak Wavelength <sup>4</sup>	$\lambda_p$	460	nm
FWHM- Spectral bandwidth at 50% of $\Phi_V$	$\Delta\lambda_{1/2}$	25	nm
Chromaticity Coordinates <sup>7</sup>	CIE x	0.140	
	CIE y	0.050	
<b>Thermal Characteristics</b>			
Thermal Resistance (junction to case) <sup>8</sup>	$R_{\theta j-c\ real}$	0.75	°C/W
Thermal Resistance at WPE = 27% (junction to case) <sup>8,9</sup>	$R_{\theta j-c\ elec}$	0.54	°C/W
Thermal Resistance at WPE = 27% (junction to thermistor) <sup>8,9</sup>	$R_{\theta j-ref\ elec}$	0.66	°C/W
Thermal Coefficient of Photometric Flux		-0.07	%/°C
Thermal Coefficient of Radiometric Flux		-0.3	%/°C
Forward Voltage Temperature Coefficient		-4.5	mV/°C

**Note:**

- All ratings are based on operation with a constant case temperature  $T_c = 25^\circ\text{C}$ .
- CFT-50X-B device can be driven at currents ranging from 100 mA to 12.5 A and at duty cycles ranging from 1% to 100%. Drive current and duty cycle should be adjusted as necessary to maintain the junction temperature desired to meet application lifetime requirements.
- Tested at Current of 7.5 A, 20 ms single pulse.
- Unless otherwise noted, values listed are typical. Devices are production tested and specified at 7.5 A.
- Total flux from emitting area at listed peak wavelength. Reported performance is included to show trends for a selected power level. For specific minimum and maximum values, use bin tables. For product roadmap and future performance of devices, contact Luminus.
- Caution must be taken not to stare at the light emitted from these LEDs. Under special circumstances, the high intensity could damage the eye.
- In CIE 1931 chromaticity diagram coordinates, normalized to  $X+Y+Z=1$ .
- Measurements are in accordance with JEDEC 51-14.
- $R_{\theta j-ref}$  is measured on a water-cooled stage with e-graf as the thermal interface material.  $R_{\theta j-ref}$  is system-dependent. For instructions on how to calculate  $R_{\theta j-ref}$  for your specific system, please refer to application brief [https://download.luminus.com/datasheets/Luminus-White-Paper-Thermal-Mgmt\\_Thermistors.pdf](https://download.luminus.com/datasheets/Luminus-White-Paper-Thermal-Mgmt_Thermistors.pdf)



**Relative Radiometric Flux-Single Pulse Mode**

Forward current:  $\phi_v/\phi_v(7.5\text{ A})$  Single Pulse 20 ms,  $T_c = 25^\circ\text{C}$

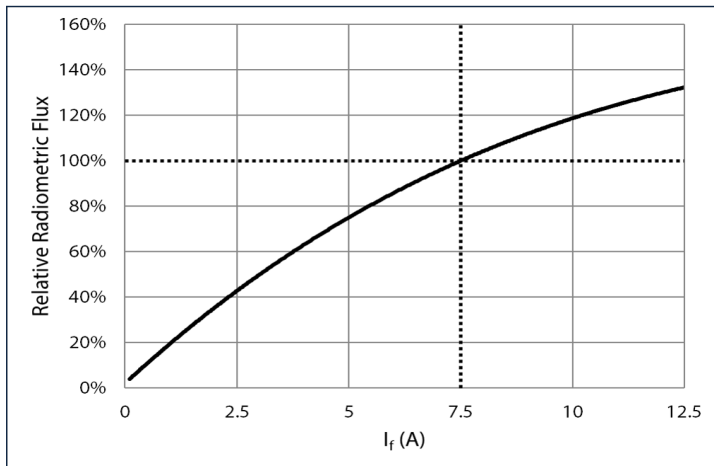

Temperature:  $\phi_v/\phi_v(25^\circ\text{C})$  Single Pulse 20 ms,  $I_f = 7.5\text{ A}$

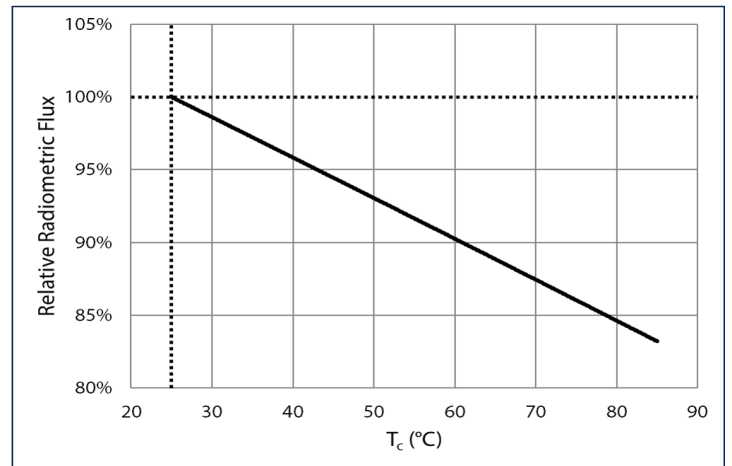

**Forward Voltage-Single Pulse Mode**

Forward current:  $\Delta V_f = V_f(I_f) - V_f(7.5\text{ A})$  Single Pulse 20 ms,  $T_c = 25^\circ\text{C}$

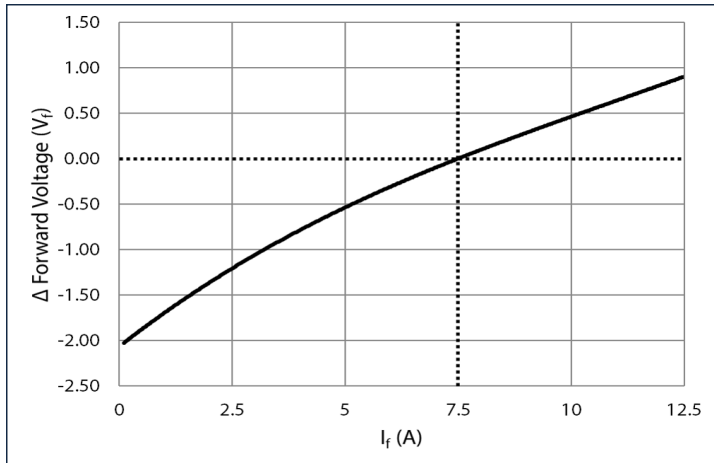

Temperature:  $\Delta V_f = V(T_c) - V(25^\circ\text{C})$  Single Pulse 20 ms,  $I_f = 7.5\text{ A}$

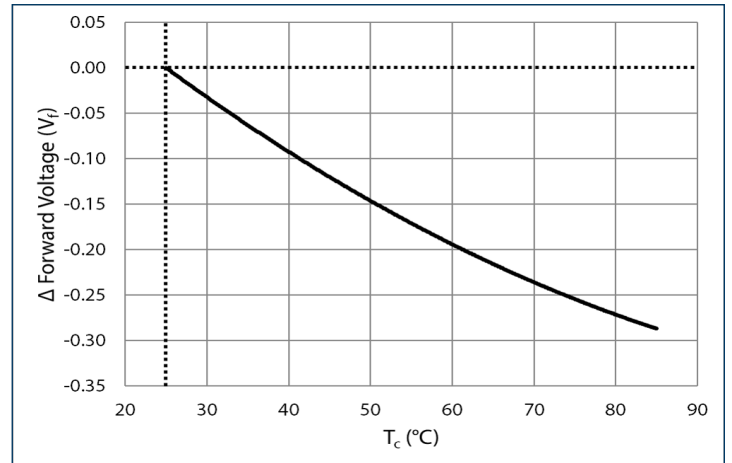

**Peak Wavelength Shift-Single Pulse Mode**

Forward current:  $\Delta \lambda_d = \lambda_d(I_f) - \lambda_d(7.5\text{ A})$  Single Pulse 20 ms,  $T_c = 25^\circ\text{C}$

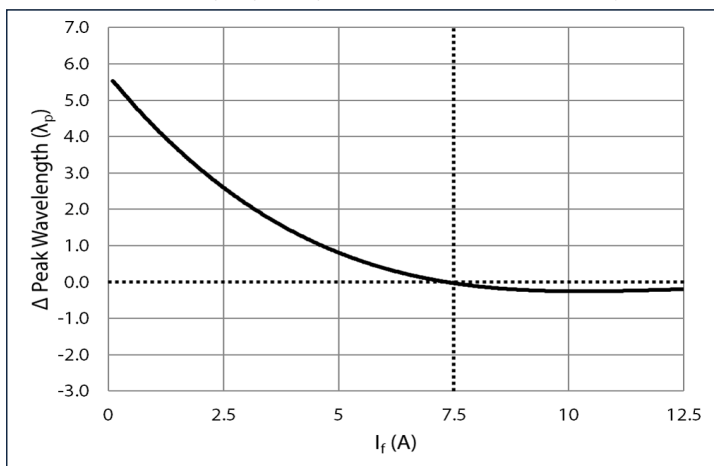

Temperature:  $\Delta \lambda_d = \lambda_d(T_c) - \lambda_d(25^\circ\text{C})$  Single Pulse 20 ms,  $I_f = 7.5\text{ A}$

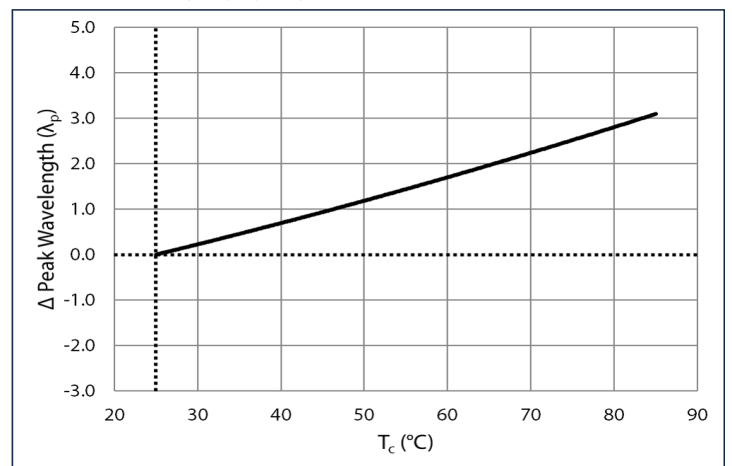



### Relative Radiometric Flux-CW Mode

Forward current:  $\phi_v/\phi_v(7.5\text{ A})$  CW,  $T_c = 40^\circ\text{C}$

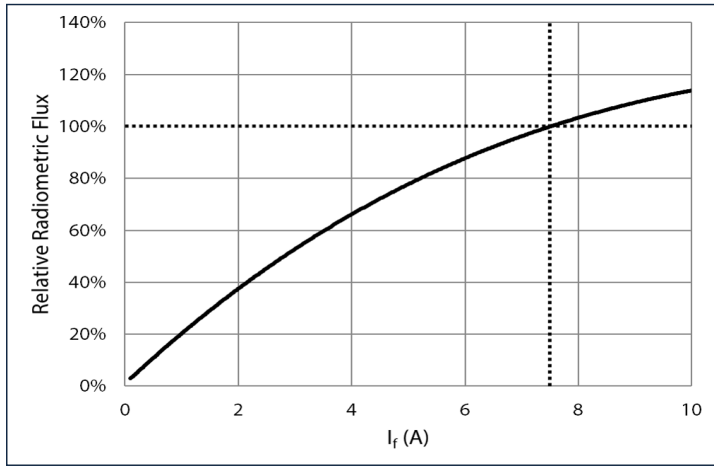

Temperature:  $\phi_v/\phi_v(40^\circ\text{C})$  CW,  $I_f = 7.5\text{ A}$

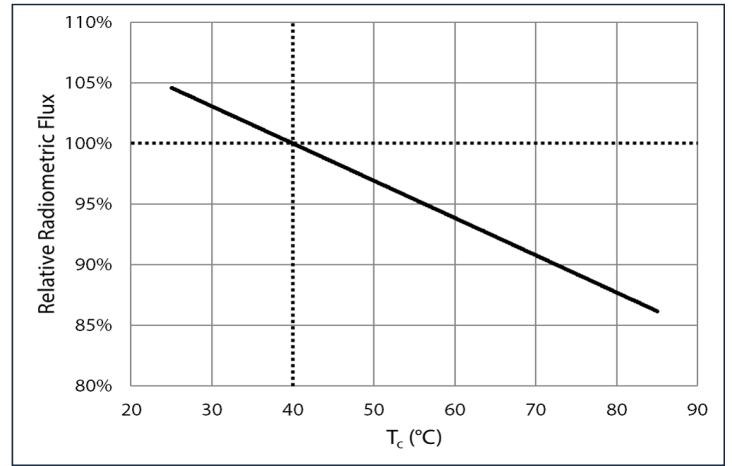

### Forward Voltage-CW Mode

Forward current:  $\Delta V_f = V_f(I_f) - V_f(7.5\text{ A})$  CW,  $T_c = 40^\circ\text{C}$

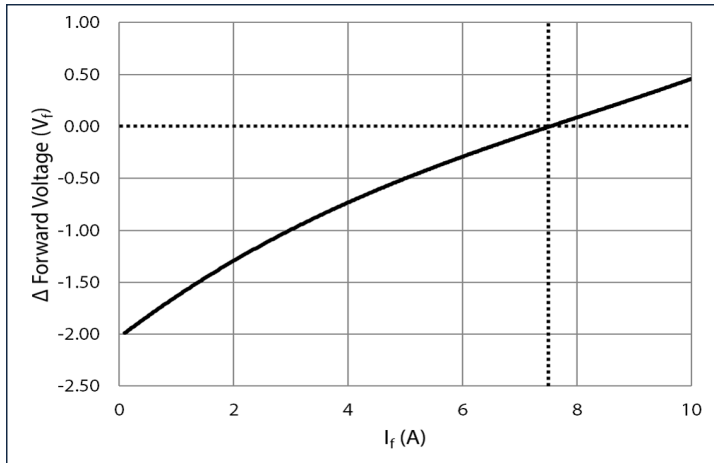

Temperature:  $\Delta V_f = V(T_c) - V(40^\circ\text{C})$  CW,  $I_f = 7.5\text{ A}$

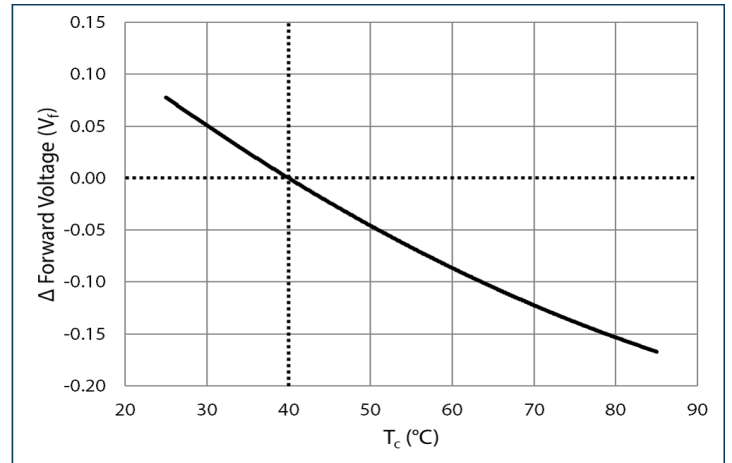

### Peak Wavelength Shift-CW Mode

Forward current:  $\Delta \lambda_d = \lambda_d(I_f) - \lambda_d(7.5\text{ A})$  CW,  $T_c = 40^\circ\text{C}$

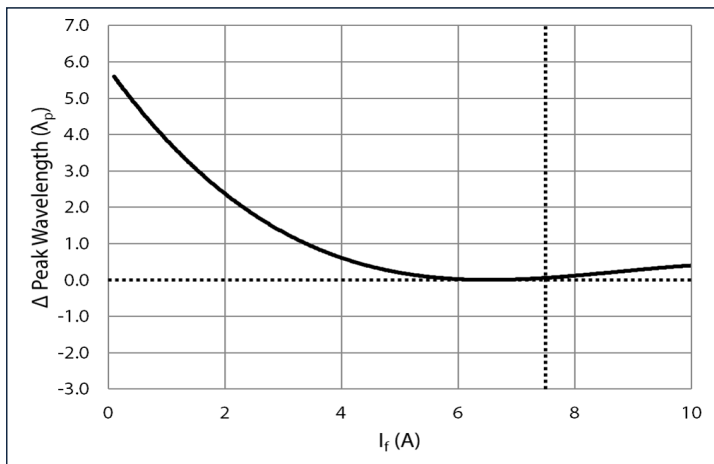

Temperature:  $\Delta \lambda_d = \lambda_d(T_c) - \lambda_d(40^\circ\text{C})$  CW,  $I_f = 7.5\text{ A}$

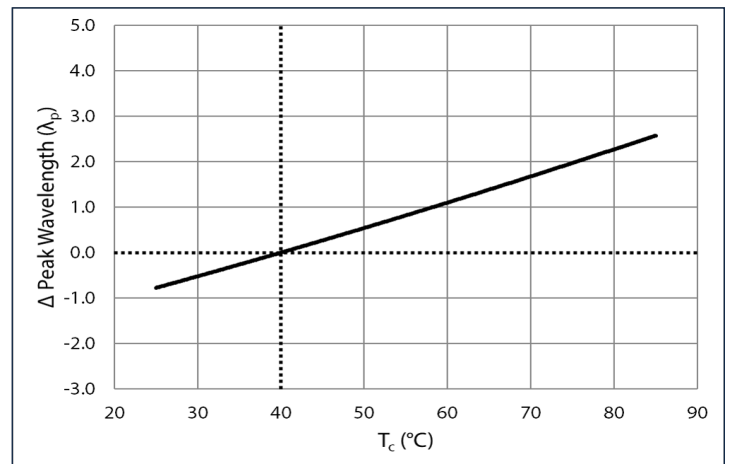



## Angular Distribution and Typical Spectrum

### Angular Intensity Distribution

$$I_{\text{ref}} = f(\Phi); T_c = 25^\circ\text{C}$$

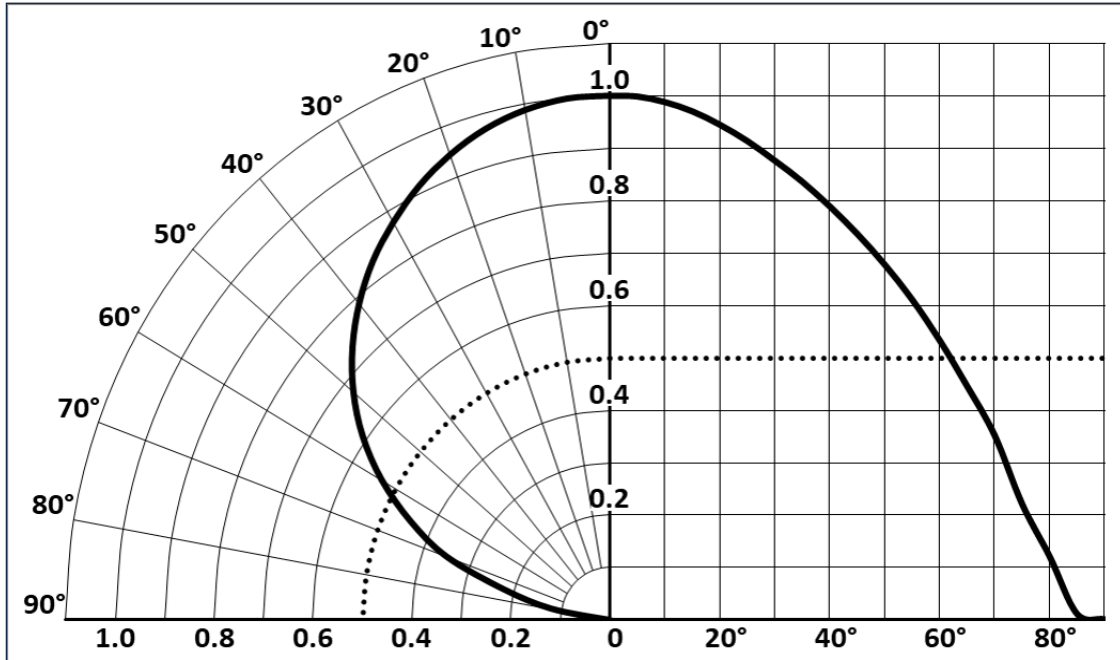

### Typical Spectrum

$$\Phi_{\text{ref}} = f(\lambda); I_f = 7.5 \text{ A}; T_c = 25^\circ\text{C}$$

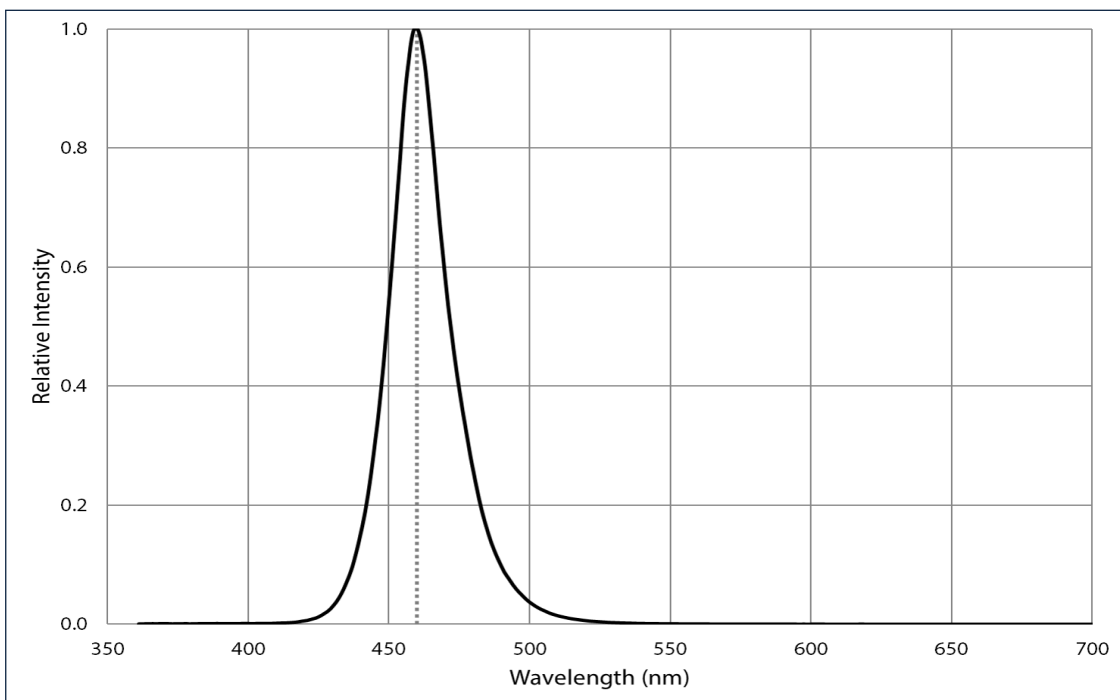





## Mechanical Dimensions

DIMENSIONS IN MILLIMETERS

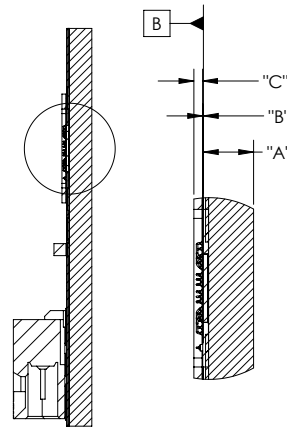
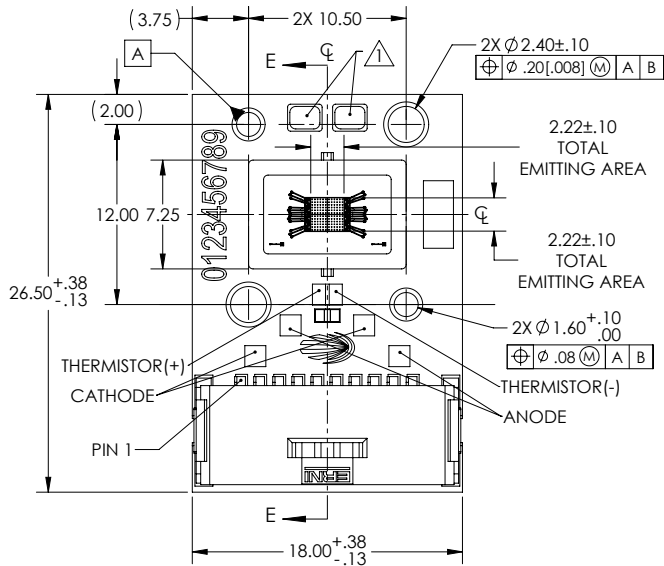
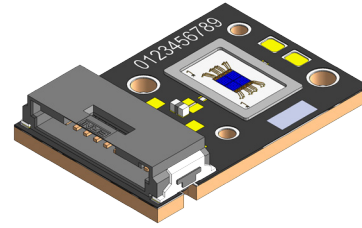

SECTION E-E

NOTES:  
 TEST PADS ARE ELECTRICALLY CONNECTED TO THE BOARD COPPER BASE.

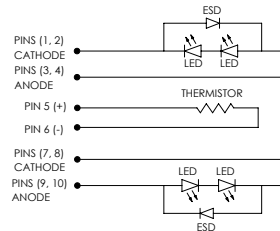

PINS 1, 2, 7, 8 (CATHODE) AND 3, 4, 9, 10 (ANODE) MUST BE POWERED SIMULTANEOUSLY

LED CIRCUIT DIAGRAM

PIN NO(S).	ASSIGNMENT
1,2	CATHODE (-)
3,4	ANODE (+)
5	THERMISTOR (+)
6	THERMISTOR (-)
7,8	CATHODE (-)
9,10	ANODE (+)

DIMENSION NAME	DESCRIPTION	NOMINAL DIMENSION	TOLERANCE
"A"	TOP OF METAL SUBSTRATE (DATUM B) TO BACK OF COREBOARD	1.67	±.10
"B"	TOP OF METAL SUBSTRATE (DATUM B) TO TOP OF EMITTING AREA	.03	±.03
"C"	TOP OF EMITTING AREA TO TOP OF FRAME	.29	±.13

DWG-003253 REV D

- For detailed drawing please refer to DWG-003253 document.
- The CFT-50X-B copper PCB is electrically neutral.
- Mating connector P/N: TE Connectivity (ERNI) 484084-E
- Check NEC standards for ampacity of the power cable being used.
- Recommended wire: MIL-W-16878/6 Type ET or equivalent
- Minimum requirements, manufacturer:
  - Gauge: AWG 22, Type: 7-strand plated copper or solid copper core
  - Maximum Outer Diameter (OD): 1.27 mm
  - Insulation material: PTFE or ETFE required for high-temperature and high-current rating



## Shipping Tray Outline

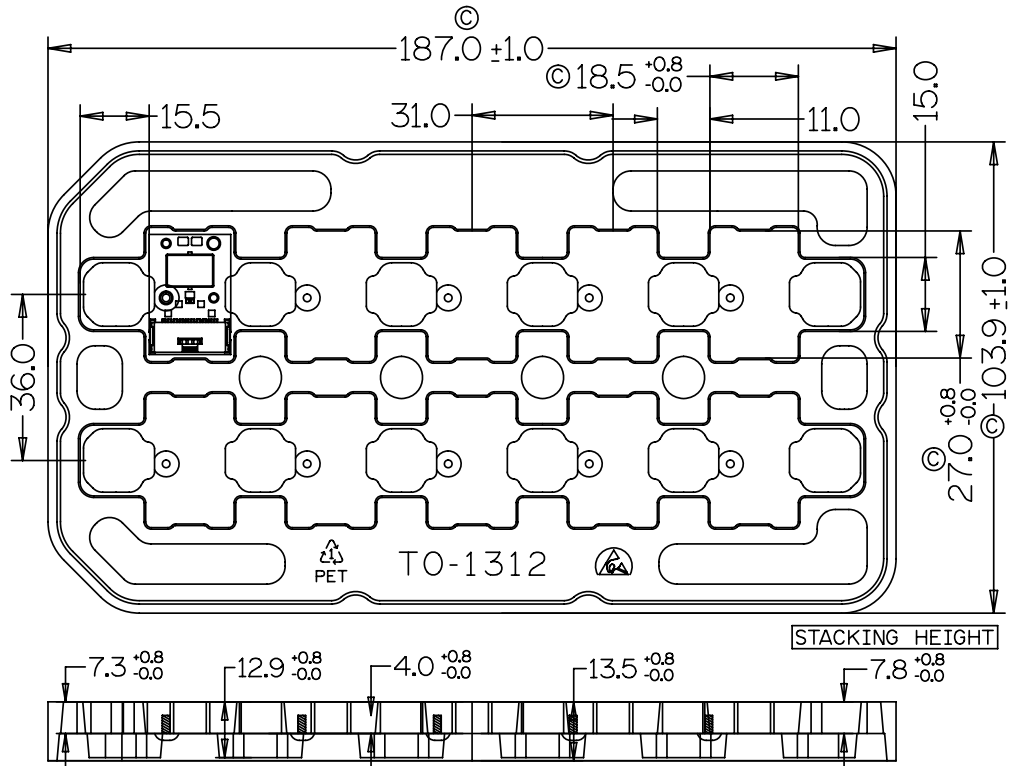

**Note:**

1. The maximum draft is 5 degrees unless otherwise stated.
2. All radii are to be 1.25 mm unless otherwise stated.
3. The surface resistivity is  $10E6 \sim 10E9$  Ohm/sq unless otherwise stated.
4. All cells are identical.
5. All dimensions are in millimeters (mm).
6. All numbers with © symbol designate a manufacturing inspection point.
7. All numbers without © symbol are for reference purposes only.
8. The material used is RoHS compliant.



## Shipping Label

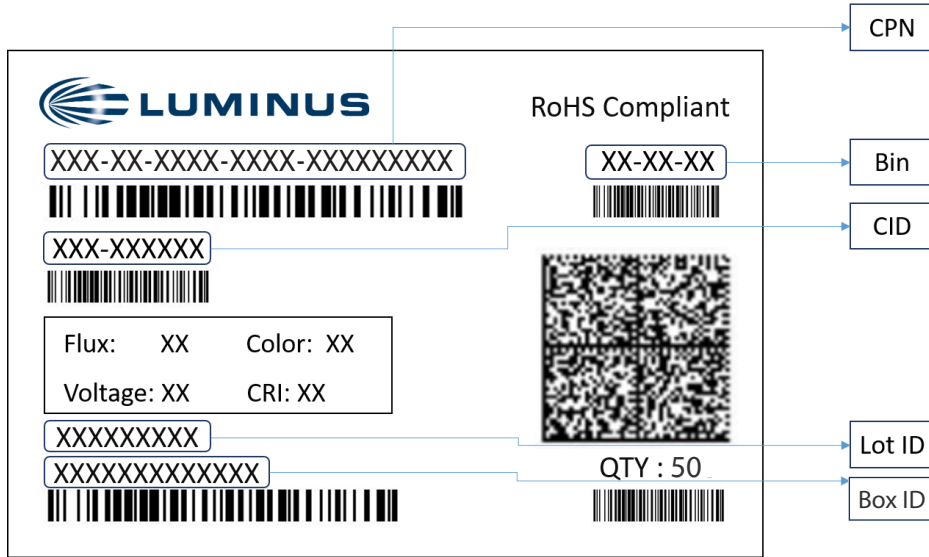

### Label Fields:

- CPN: Luminus ordering part number
- CID: Customer's part number
- QTY: Quantity of devices in pack
- Flux: Bin as defined on page 3
- Voltage: NA
- Color: Bin as defined on page 3
- CRI: NA

### Packing Configuration:

- Maximum stack of 5 trays per pack with 10 devices per tray
- Partial pack or tray may be shipped
- Each pack is enclosed in anti-static bag
- Shipping label is placed on top of each pack



## Notes

### Static Electricity

This product is sensitive to static electricity, and care should be taken when handling them. Static electricity or surge voltage will damage the LEDs. It is recommended to wear an anti-electrostatic wristband or anti-electrostatic gloves when handling the LEDs. All devices, equipment and machinery must be properly grounded. It is recommended that measures be taken to isolate LED processing equipment from potential sources of voltage surges.

Reference: APN-002815 Electrical Stress Damage to LEDs and How to Prevent It

### Eye Safety

According to the test specification risk group IEC 62471: 2006-Worst case under 10 A, this product complies to Risk group 2 (RG2) Moderate risk.

Do not stare at operating lamp, may be harmful to the eyes.

For more information, please refer to: <https://luminusdevices.zendesk.com/hc/en-us/articles/10532958752397>.



## Revision History

Rev	Date	Description of Change
01	11/25/2024	Initial release.