

Gen6+ Series CXM-11

COB Arrays White LED



Features

- High lumen output and efficacy typical
- Over 2135 lm, 142 LPW @ 3000K, 90CRI, $T_j = 85^\circ\text{C}$
- CCT range 2700K, 3000K, 3500K, 4000K, 5000K, 6500K
- 3 SDCM and 2 SDCM color binning standard
- Excellent optical emission uniformity and color over angle consistency
- Superior thermal conductivity for uniform heat spreading



Table of Contents

Ordering Information.	2
Binning Structure.	4
Absolute Maximum Ratings.	5
Characteristics	6
Angular Distribution and Typical Spectrum.	8
Derating Curve	9
Mechanical Dimensions.	10
Shipping Tray Outline	11
Shipping Label	12
Technology Overview.	13
Test Specifications	13
Handling Notes	14
Revision History	16

Applications

- Spotlights/Track Lights
- Downlights
- Shop Lighting
- Hospitality Lighting
- Architectural and Specialty
- Street Lighting
- Parking Lot and Area Lighting
- Tunnel Lighting



Ordering Information

Ordering Part Numbers

The following tables describe products with typical flux and minimum flux measured at 450 mA and specified at $T_j = 85^\circ\text{C}$. The values at 25°C are calculated and shown for reference only.

Minimum CRI ²	CCT	Luminous Flux ¹			Ordering Part Number	
		Typical Flux (85°C)	Minimum Flux (85°C)	Calculated Typical Flux (25°C)	3-step MacAdam Ellipse	2-step MacAdam Ellipse
90	2700	2035	1890	2240	CXM-11-27-90-36-TC80-F9-3	CXM-11-27-90-36-TC80-F9-2
95		1805	1680	1985	CXM-11-27-95-36-TC80-F9-3	CXM-11-27-95-36-TC80-F9-2
90	3000	2135	1985	2350	CXM-11-30-90-36-TC80-F9-3	CXM-11-30-90-36-TC80-F9-2
95		1930	1795	2125	CXM-11-30-95-36-TC80-F9-3	CXM-11-30-95-36-TC80-F9-2
90	3500	2205	2050	2425	CXM-11-35-90-36-TC80-F9-3	CXM-11-35-90-36-TC80-F9-2
95		2015	1875	2215	CXM-11-35-95-36-TC80-F9-3	CXM-11-35-95-36-TC80-F9-2
90	4000	2275	2115	2505	CXM-11-40-90-36-TC80-F9-3	CXM-11-40-90-36-TC80-F9-2
95		2095	1950	2305	CXM-11-40-95-36-TC80-F9-3	CXM-11-40-95-36-TC80-F9-2
90	5000	2315	2155	2545	CXM-11-50-90-36-TC80-F9-3	CXM-11-50-90-36-TC80-F9-2
95		2130	1980	2345	CXM-11-50-95-36-TC80-F9-3	CXM-11-50-95-36-TC80-F9-2
90	6500	2320	2160	2550	CXM-11-65-90-36-TC80-F9-3	CXM-11-65-90-36-TC80-F9-2

Notes:

1. Luminus maintains a +/- 6% tolerance on flux measurements.
2. Luminus maintains a +/- 2% tolerance on CRI measurements.



Ordering Information

Part Number Nomenclature

All Luminus COB products are packaged and labeled with part numbers as outlined in the table on page 2. Luminus may include any smaller chromaticity bin that is contained in the larger bin as part of the ordered part. When shipped, each package will contain only a single flux and chromaticity bin. The part number designation is as follows:

CXM	11	NN	XX	VV	QQPP	FG	W
Product Family	LES ¹	CCT ²	Minimum CRI ³	Typical Voltage	Package Configurator ⁴	Flux Bin	Chromaticity Bin
Chip on Board, Multi-die	11 mm LES diameter	See Note 2 below	90: CRI > 90 95: CRI > 95	Volts (V) 36: 36V	TC80	Lumens	See page 4 for bins

Notes:

- Light Emitting Surface (LES) Diameter.
- Correlated Color Temperature (CCT), NN nomenclature corresponds to the following:

27 = 2700K	40 = 4000K
30 = 3000K	50 = 5000K
35 = 3500K	65 = 6500K
- Minimum Color Rendering Index (CRI).
- TC is a standard substrate with sulfur resistance process; 8 means Gen6+ COB products, 0 means a product with chromaticity on the BBL.
- Luminus part numbers may be accompanied by prefixes or suffixes. The most common is the "Rev01" suffix indicating a part is fully released and carries a full warranty. These additional characters may appear on shipping labels, packing slips and invoices. In all cases the basic part number described above will always be included.

CCT, CRI and R9 Values

Correlated Color Temperatures	XX Value	CRI	R9 ¹
2700K, 3000K, 3500K, 4000K, 5000K, 6500K	90	>90	>50
2700K, 3000K	95	>95	>85
3500K, 4000K, 5000K			>75

Note:

- R9 values have a tolerance of +/- 5%.



Binning Structure

Chromaticity Binning Diagram ¹

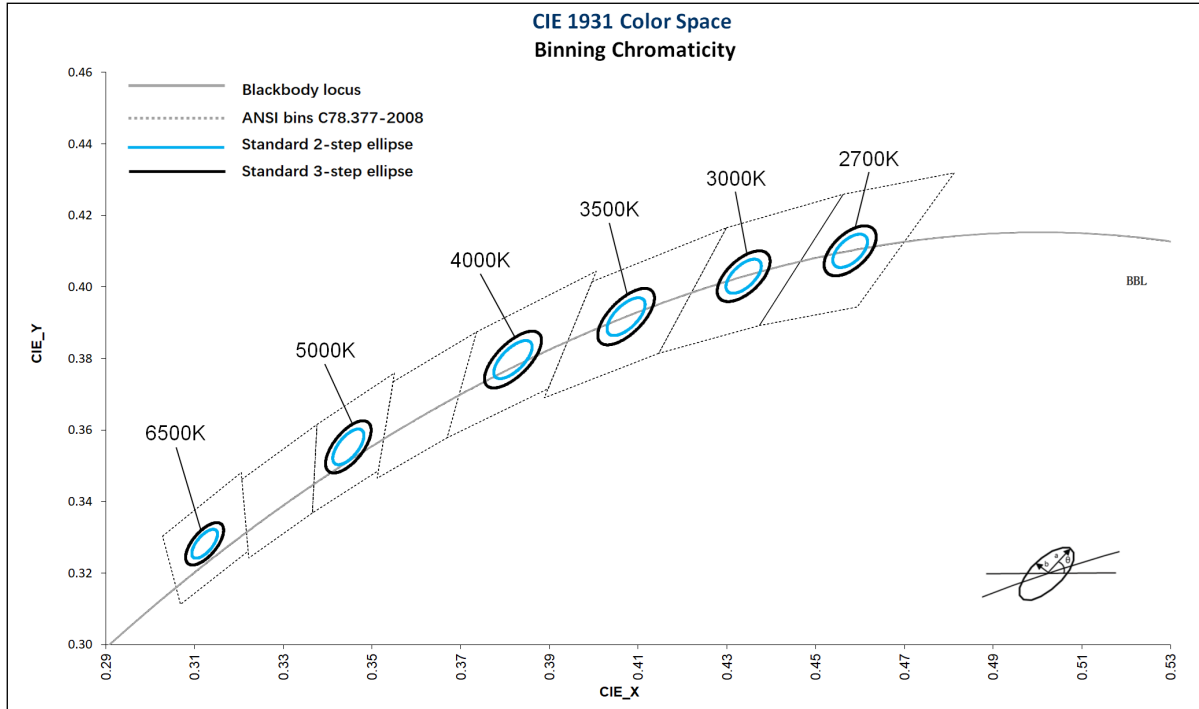

The following tables describe the chromaticity bin center points, the orientation angle for the MacAdam ellipse, and the maximum radii for the ellipses. The ANSI Bins are provided for reference.

CCT	Center point		Angle(deg)	3-step Bin		2-step Bin	
	x	y	Φ	a	b	a	b
2700K	0.4578	0.4101	53.7	0.0081	0.0042	0.0054	0.0028
3000K	0.4338	0.4030	53.2	0.0083	0.0041	0.0056	0.0027
3500K	0.4073	0.3917	54.0	0.0093	0.0041	0.0062	0.0028
4000K	0.3818	0.3797	53.7	0.0094	0.0040	0.0063	0.0027
5000K	0.3447	0.3553	59.6	0.0082	0.0035	0.0055	0.0023
6500K	0.3123	0.3282	58.6	0.0067	0.0029	0.0045	0.0019

Note:

1. Luminus maintains a +/- 0.005 tolerance on chromaticity (CIE_x and CIE_y) measurements.



Absolute Maximum Ratings

Parameter		Symbol	Value	Unit
Forward Current	Typical	$I_{f\text{ typ}}$	450	mA
	Maximum	$I_{f\text{ max}}$	1440	
Power Dissipation	Typical	$P_{d\text{ typ}}$	15.1	W
	Maximum	$P_{d\text{ max}}$	56.7	
Operating Case Temperature	Maximum	T_c	120	°C
Junction Temperature	Maximum	T_j	140	°C



Characteristics^{1,2,3}

Parameter		Symbol	Value	Unit
Light Emitting Surface Diameter		LES	11.7	mm
Forward Voltage	Minimum	$V_{f\ min}$	31.0	V
	Typical	$V_{f\ typ}$	33.5	
	Maximum	$V_{f\ max}$	37.0	
Viewing Angle		$2\theta_{1/2}$	120	°
Thermal Resistance (junction-to-case)		$R_{th\ J-C}$	0.32	°C/W

Notes:

1. Device measurements are at $T_j = 85^\circ\text{C}$.
2. To prevent damage refer to operating conditions and derating curves for appropriate maximum operating conditions.
3. Voltage is rated at typical forward current. For voltage at higher drive current, refer to performance graphs.
4. Please use ray files for all optics designs.
5. Device operation not recommended at drive currents less than 10% of the typical value.
6. Caution must be taken not to stare at the light emitted from these LEDs. Under special circumstances, the high intensity could damage the eye.
7. All product operating specifications are subject to change without advance notice.



Relative Luminous Flux vs Forward Current

$T_j = 85^\circ\text{C}$

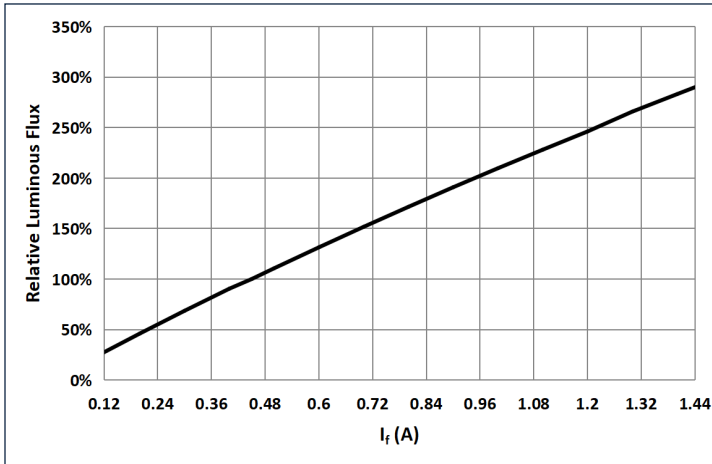

Relative Luminous Flux vs Temperature

$I_f = 450\text{ mA}$

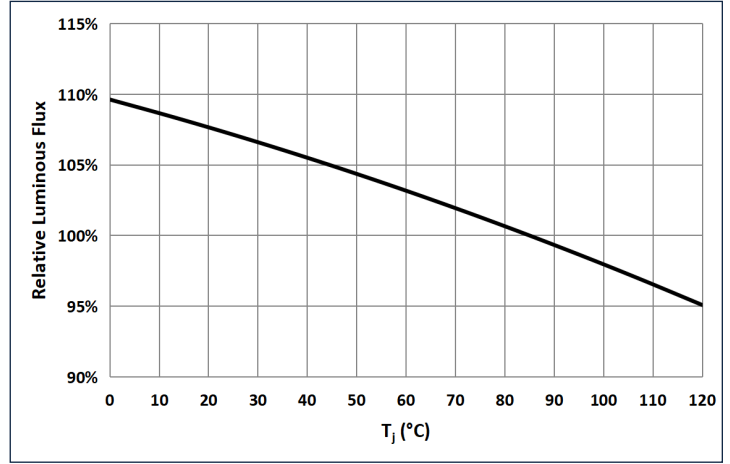

Forward Voltage vs Forward Current

$T_j = 85^\circ\text{C}$

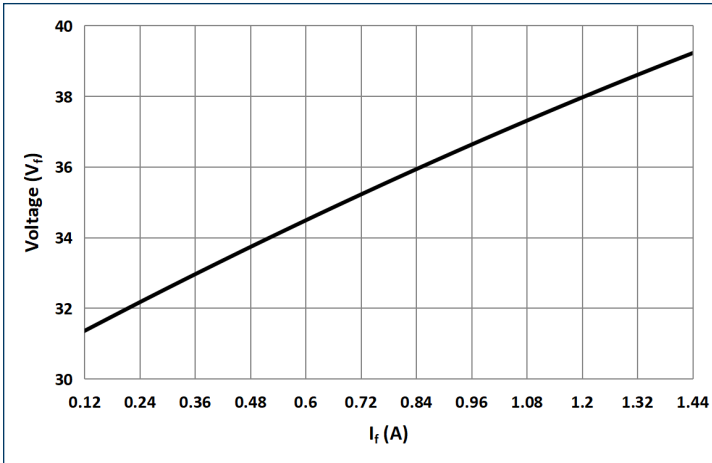

Forward Voltage vs Temperature

$I_f = 450\text{ mA}$

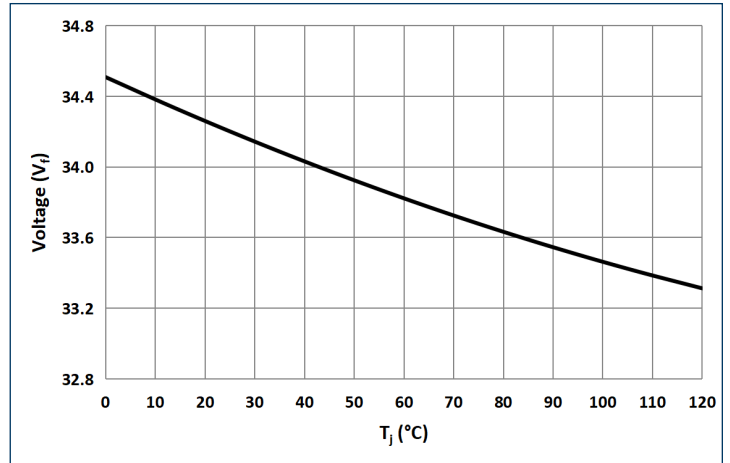

Relative Chromaticity vs Forward Current

$T_j = 85^\circ\text{C}$

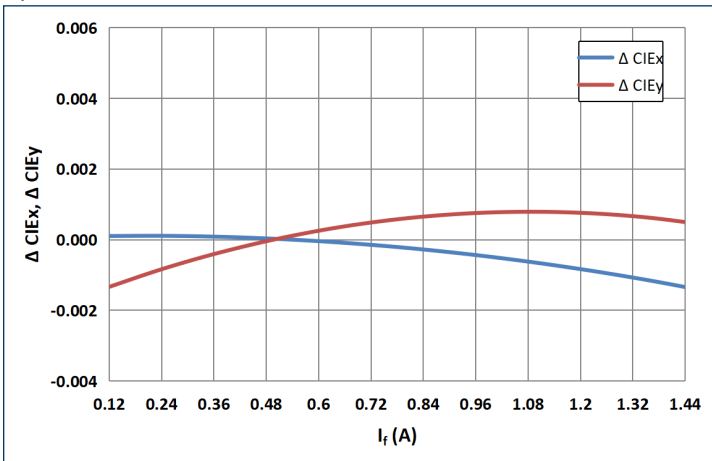

Relative Chromaticity vs Temperature

$I_f = 450\text{ mA}$

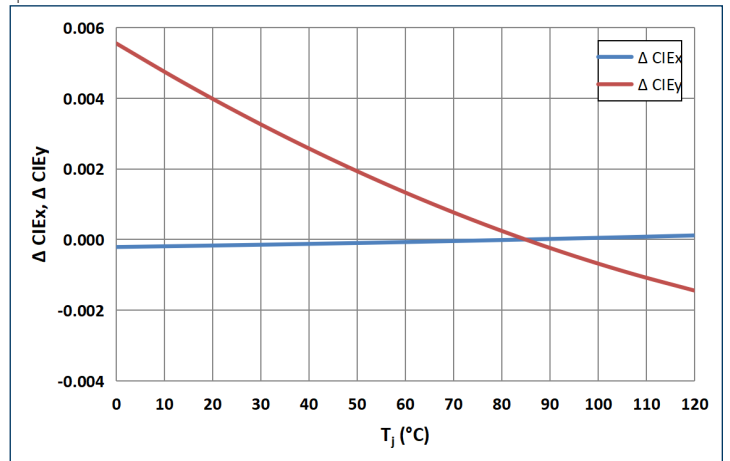



Angular Distribution and Typical Spectrum

Angular Distribution

$T_j = 85^\circ\text{C}$

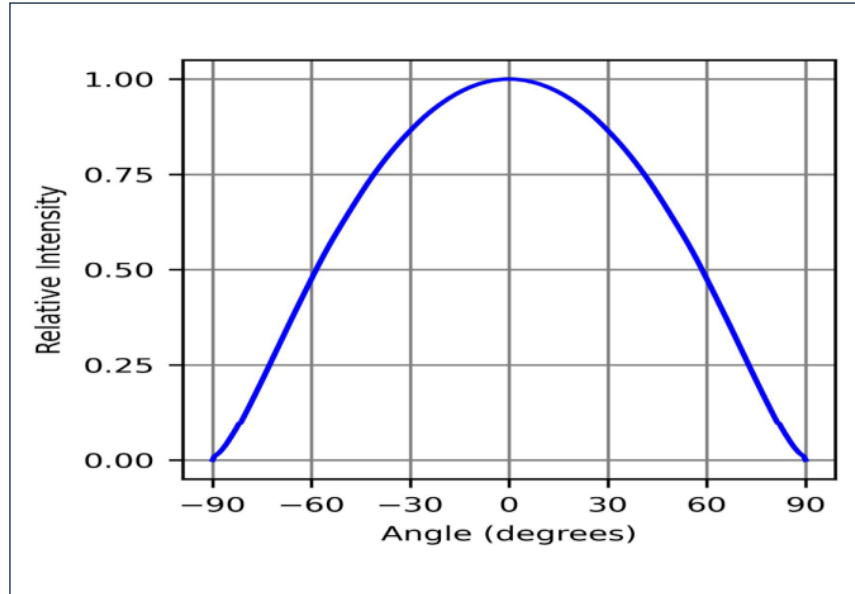

Polar Distribution

$T_j = 85^\circ\text{C}$

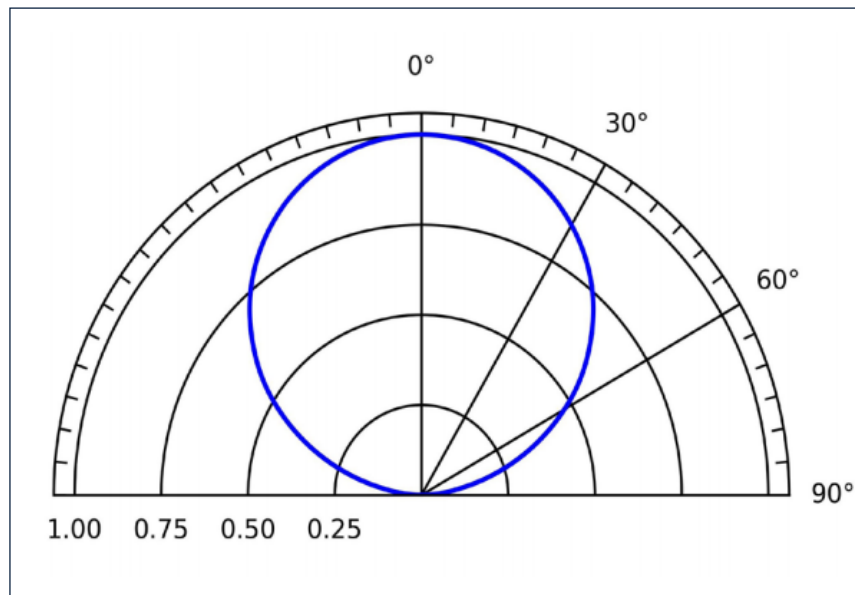



Relative Spectral Power Distribution

$T_j = 85^\circ\text{C}$

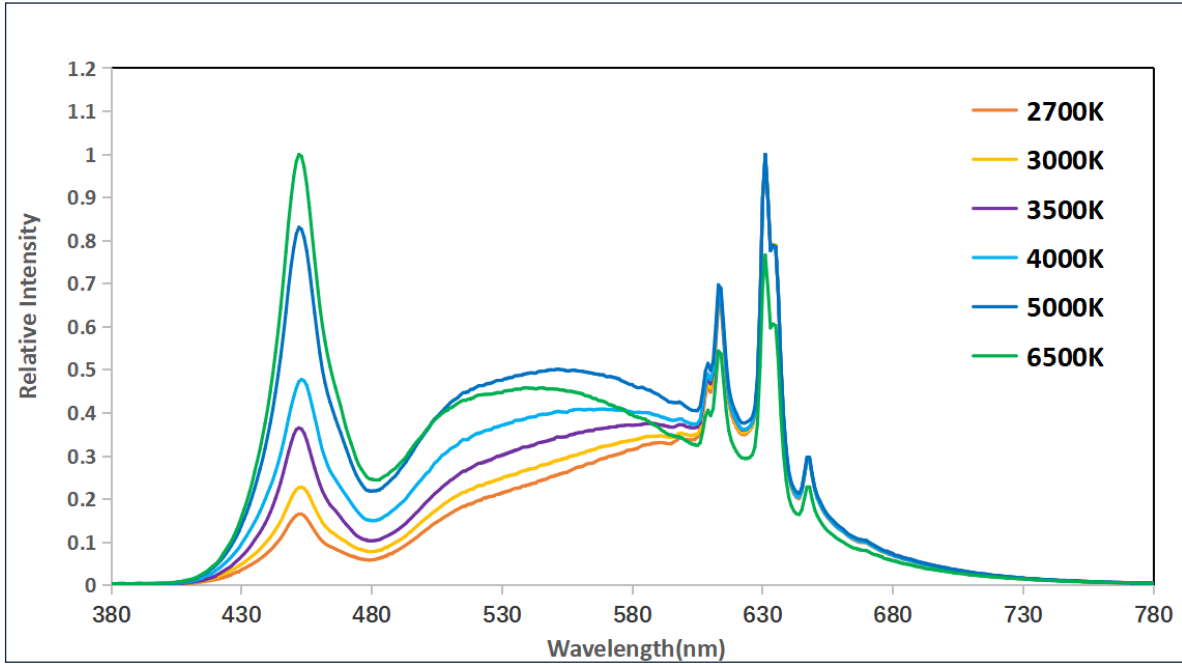

Derating Curve

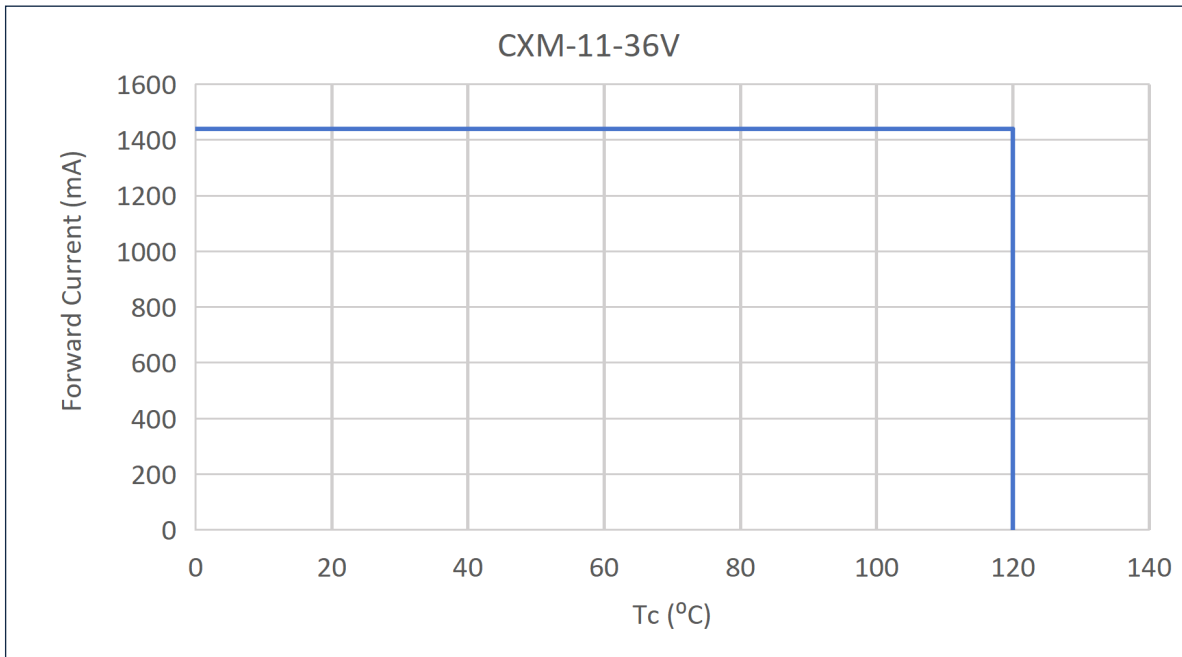



Mechanical Dimensions¹

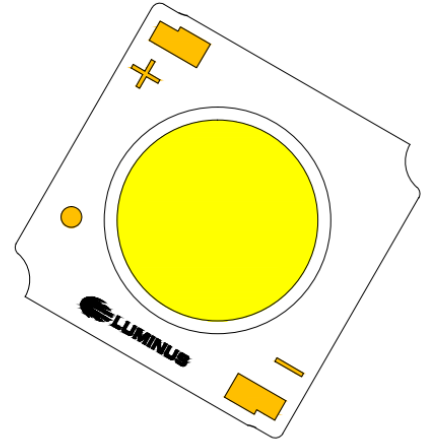
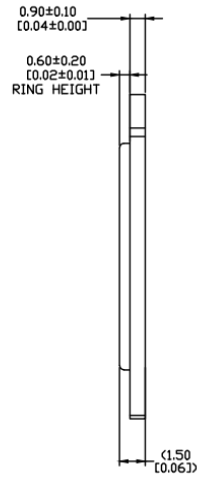
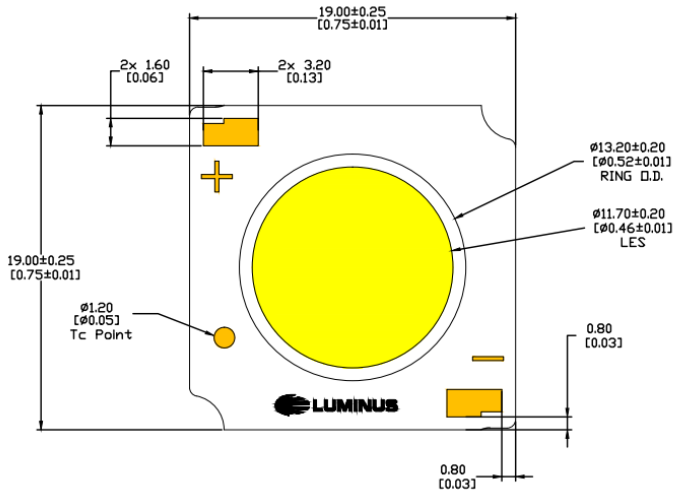

Note:

1. Unless otherwise specified, tolerance is $\pm 0.3\text{mm}$.



Shipping Tray Outline



Packing Configuration:

- 45 pcs per tray and 5 trays are stacked together to be sealed in an anti-static bag.
- The anti-static bag is boxed for easier storage, 225 pcs per box.



Shipping Label

Label on Packaging Box

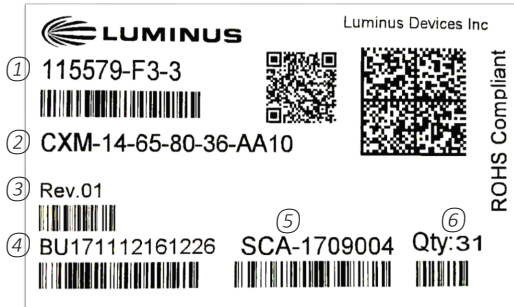

Label model -- for illustration only

Notes:

- ① Manufacturer part number, flux bin and chromaticity bin
- ② Customer part number
- ③ Rev.01 indicates a fully released product
- ④ Box ID
- ⑤ Production ID
- ⑥ Total number of units in a box



Technology Overview

Luminus Chip-on-Board (COB) LED series have consistently delivered the highest lumen performance with the best color quality of any COB supplier. Driving performance enhancements through each generations of COB products has provided Luminus a comprehensive understanding of the lighting market for directional sources positioning Luminus as the COB manufacturer of choice for the most discriminating lighting manufacturers.

Reliability

Designed from the ground up, the Luminus COB LED is one of the most reliable light sources in the world today.

UL and IEC Recognized Compliance

Luminus COB arrays are tested in accordance with ANSI/UL 8750 to ensure safe operation for their intended applications. Further, Luminus maintains IEC-62031 safety ratings on all COB products.

REACH & RoHS Compliance

All LED products manufactured by Luminus are REACH and RoHS compliant and free of hazardous materials, including lead and mercury.

Test Specifications

Every Luminus LED is fully tested to ensure it meets the high quality standards customers have come to expect from Luminus' products.

Traceability

Each Luminus COB LED is marked with a 2D bar code that contains a unique serial number. With this serial number, Luminus has the ability to provide customers with actual test data measurements for a specific LED. In addition, the 2D bar code is linked to manufacturing date codes that enables traceability of production processes and materials.

Testing Temperature

Luminus COB products are measured at temperatures typical for the LED operating in the fixture. Each device is tested at 85°C junction temperature eliminating the need to scale data sheet specifications to real world situations.

Chromaticity Bin Range

Chromaticity binning delivers color consistency for every order. Standard products are delivered with a 3-step MacAdam ellipse. This ensures color performance matching in the application. For the most demanding application, Luminus is one of only a few companies that can provide a 2 SDCM bin distribution. These tightly controlled, small distribution bins provide customers predictable, repeatable colors.



Handling Notes

Luminus products are designed for robust performance in general lighting application. However, care must be taken when handling and assembling the LEDs into their fixtures. To avoid damaging Luminus COBs please follow these guidelines.

The following is an overview of the application notes detailing some of the practices to follow when working with these devices. More detailed information is available on the Luminus web site at www.luminus.com.

General Handling

Devices are made to be lifted or carried with tweezers on two adjacent corners opposite the contact pads. At no time should the devices be handled by or should anything come in contact with the light emitting surface (LES) area. This area includes the yellow colored circular area and the ring surrounding it. There are electrical connections under the LES which if damaged will cause the device to fail. In addition, the ring frame itself should not be used for moving, lifting or carrying the device. Also do not attach any optics or mechanical holders to the ring as it is not capable of handling the mechanical stress.

Storage Condition

Please follow the conditions below.

Before opening	Temperature 5~30°C, relative humidity less than 60%.
After opening	Temperature 5~30°C, relative humidity less than 60%. After opening, LED should be kept in an aluminum moisture proof bag with a moisture absorbent material.
Avoid Corrosive gas	Avoid exposing to air with corrosive gas. If exposed, contact pad solderability may be affected. More detailed information is available on the Luminus Applications Resources web pages.

Static Electricity

Luminus COBs are electronic devices which can be damaged by electrostatic discharge (ESD). Please use appropriate measures to assure the devices do not experience ESD during their handling and or storage. ESD protection guidelines should be used at all time when working with Luminus COBs.

Storage	Luminus products are delivered in ESD shielded bags and should be stored in these bags until used.
Transporting	When transporting the devices from one assembly area to another, ESD shielded carts and carriers should be used.
Assembly	Individuals handling Luminus COBs during assembly should be trained in ESD protection practices. Assemblers should maintain constant conductive contact with a path to ground by means of a wrist strap, ankle straps, mat or other ESD protection system.



Chemical Compatibility

The resin material used to form the LES can get hydrocarbons from the surrounding environment. As a result, certain chemical compounds (H₂SO₄, H₂S, SO₂, NH₃, H₃PO₄, etc.) are not recommended for use with the Luminus products. Use of these compounds can cause damage to the light output of the device and may permanently damage the device. Please refer to the table below for a list of the compounds not recommended for use with the Luminus COB products.

Common Chemicals Know to Adversely Affect Luminus Devices		
Acetates	Ethers	Potassium hydroxide
Acetic acid	Cl, F or Br containing compounds	Siloxanes
Acrylates	Liquid hydrocarbons	Sodium Hydroxide
Aldehydes	Hydrochloric Acid	Sulfur compounds
Aldehydes	Ketones	Sulfuric Acid
Amines	Nitric Acid	Toluene
Benzene	Phosphoric acid	Xylenes
Dienes		

Thermal Interface Material (TIM)

Proper thermal management is critical for successful operation of any LED system. Excess operating temperature can reduce the light output of the device. Excessive heating can cause permanent damage to the device. Proper TIM material is a crucial component for effective heat transfer away from the LED during normal operation. Please refer to www.luminus.com for specific recommendations for TIM solutions.

Please refer to https://download.luminus.com/datasheets/Luminus_APN-002319_Rev_04.pdf for more application note information.



Revision History

Rev	Date	Description of Change
A	11/28/2025	Initial release
01	01/27/2026	Add product photo, Thermal Resistance