

MP-1616

Luminus SMD LED



Table of Contents

Technology Overview	2
Product Selection Table	3
Operating Characteristics	4
Chromaticity Binning.	5
Chromaticity Diagram.	6
Characteristic Graphs	7 & 8
Ordering Information	9
Product Dimensions.	10
Solder Pad Pattern	10
Dimensions of Tape	11
Reel Dimensions	12
Reel Packaging.	12
Box Packaging	13

Features:

- Wide viewing angle: 170 degrees
- Hot lumen color targeted
- 1.63W maximum operating input power
- Compact: 1.6mm x 1.6mm
- High efficacy: up to 143 lumens per watt
- Wide color selection: 2700K-5000K
- 6V input
- Compatible with automatic placement equipment
- Compatible with infrared reflow solder process
- RoHs and REACH compliant

Applications

- Replacement lamps
- Panel lighting
- Down lights
- Cove lighting
- Architectural lighting
- Channel lighting

Technology Overview

Luminus XNOVA Cube™ LEDs are lighting class solutions designed for high performance general lighting applications. These state-of-the-art LEDs allow illumination engineers and designers to develop lighting solutions with maximum efficacy, brightness and overall quality. The XNOVA Cube™ is a unique LED that provides the benefits of a wide emission angle within a compact footprint. The 1.9mm x 1.9mm package emits into a 170 degree viewing angle, enabling designers with new degrees of freedom to solve many of today's most challenging lighting problems. The very wide viewing angle promotes Energy Star compliance for replacement lamps, and results in increased mixing and uniformity for linear and area lighting. The miniature package size with high lumen density creates a "point source" of light that provides flexibility to develop innovative optical solutions. Additionally, the XNOVA Cube advances the hallmark characteristics of the XNOVA family, including high efficacy and color fidelity. XNOVA LEDs – the right choice for color quality, efficacy and reliability.

Reliability

The XNOVA Cube is one of the most reliable light sources in the world today. Having passed a rigorous suite of environmental and mechanical stress tests, including mechanical shock, vibration, temperature cycling and humidity, it is fully qualified for use in a wide range of high performance and high efficacy lighting applications.

REACH & RoHS Compliance

The XNOVA Cube LED is compliant to the Restriction of Hazardous Substances Directive or RoHS.

Understanding XNova™ LED Test Specifications

Every XNOVA LED is fully tested to ensure it meets the high quality standards customers have come to expect from Luminus products.

Testing Temperature

XNOVA Cube MP-1616 LEDs are tested at 25°C and binned so that the resultant chromaticity is along the blackbody locus at typical operating conditions.

Product Selection Table

Test condition = 150 mA, 25C

Nominal CCT	Minimum CRI	Ordering Part Number	Minimum Flux (Lumens)	Typical Flux (Lumens)
1800K	80	MP-1616-2100-18-80	78	84
	90	MP-1616-2100-18-90	66	75
2200K	80	MP-1616-2100-22-80	94	103
	90	MP-1616-2100-22-90	86	93
2700K	80	MP-1616-2100-27-80	107	118
	90	MP-1616-2100-27-90	94	106
3000K	80	MP-1616-2100-30-80	107	121
	90	MP-1616-2100-30-90	94	108
3500K	80	MP-1616-2100-35-80	107	124
	90	MP-1616-2100-35-90	100	112
4000K	80	MP-1616-2100-40-80	114	131
	90	MP-1616-2100-40-90	107	118
5000K	80	MP-1616-2100-50-80	114	131
	90	MP-1616-2100-50-90	107	118
5700K	80	MP-1616-2100-57-80	114	131
	90	MP-1616-2100-57-90	107	118
6500K	80	MP-1616-2100-65-80	114	131
	90	MP-1616-2100-65-90	107	118

1616 Mid Power Operating Characteristics

Optical and Electrical Characteristics(Ta=25°C)

Parameter	Symbol	Minimum	Typical	Maximum	Unit	Condition
Forward Voltage	V _F		6.2	6.9	V	I _F =150mA
Reverse Current	I _R			10	uA	V _R =5V
Viewing Angle	2θ1/2		170		°	I _F =150mA
Thermal Resistance	R _{th} _{J-sp}		12		°C/W	I _F =150mA
Electrostatic Discharge	ESD	1000			V	

Note 1: To prevent damage refer to operating conditions and derating curves for appropriate maximum operating conditions

Note 2: Maximum operating case temperature combined with maximum drive current defines the total maximum operating condition for the device. To prevent damage, please follow derating curves for all operating conditions.

Note 3: XNOVA Cube are designed for operation up to an absolute maximum forward drive current as specified below. Product lifetime data is specified at typical forward drive currents. Sustained operation at absolute maximum currents will result in a reduction of device lifetime compared to typical forward drive currents. Actual device lifetimes will also depend on case temperature. Refer to the current vs. case temperature derating curves for further information.

Note 4: Caution must be taken not to stare at the light emitted from these LEDs. Under special circumstances, the high intensity could damage the eye.

Absolute Maximum Ratings (Ta=25°C)

Parameter	Symbol	Rating	Unit
Forward Current	I _F	200	mA
Pulse Forward Current	I _{FP}	300	mA
Power Dissipation	P _D	1,632	mW
Reverse Voltage	V _R	5	V
Operating Temperature	T _{OPR}	-40~+80	°C
Storage Temperature	T _{STG}	-40~+80	°C
Junction Temperature	T _J	125	°C
Soldering Temperature	T _{SLD}	230 °C or 260 °C for 10 sec	

*I_{FP} condition with Pulse: Width ≤100μs Duty cycle ≤1/10

Chromaticity Binning

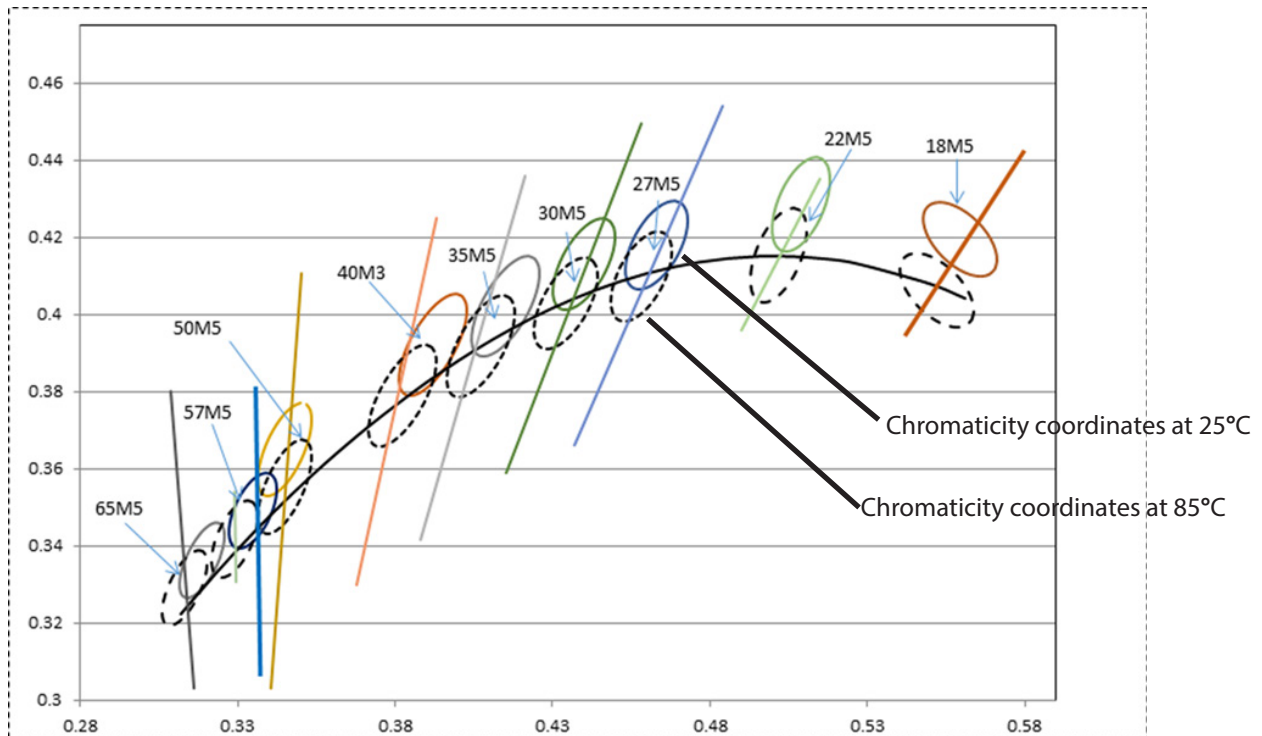

Chromaticity Binning

The chart above shows the typical chromaticity shift from 25°C to 65°C. XNOVA Cube MP-1616 LEDs are tested at 25°C and binned so that the resultant chromaticity is along the blackbody locus at typical operating conditions.

*Notes: m3 denotes a 3-step MacAdam ellipse, m5 denotes a 5-Step MacAdam ellipse.

Luminus maintains a +/- 0.01 tolerance on chromaticity (CIEx and CIEy) measurements.

Chromaticity Diagram

Color Bin Structure

CCT (K)	Steps	Center		Radius		Angle(Deg)
		x	y	a	b	Φ
1800	5	0.5592	0.4196	0.0675	0.035	-35
2200	3	0.509873	0.42036	0.0294	0.0144	45.5
	5	0.509873	0.42036	0.0815	0.04	45.5
2700	3	0.4649	0.4174	0.0081	0.0042	53.42
	5	0.4649	0.4174	0.0135	0.007	53.42
3000	3	0.4426	0.4106	0.00834	0.00408	53.13
	5	0.4426	0.4106	0.0139	0.0068	53.13
3500	3	0.4154	0.4025	0.00927	0.00414	54
	5	0.4154	0.4025	0.01545	0.0069	54
4000	3	0.3918	0.3915	0.00939	0.00402	53.43
	5	0.3918	0.3915	0.01565	0.0067	53.43
5000	3	0.353	0.3665	0.00822	0.00354	59.37
	5	0.353	0.3665	0.0137	0.0059	59.37
5700	3	0.3392	0.354	0.006705	0.0033	58.35
	5	0.3392	0.354	0.011175	0.0055	58.35
6500	3	0.31919	0.3388	0.00669	0.00285	58.34
	5	0.31919	0.3388	0.01115	0.00475	58.34

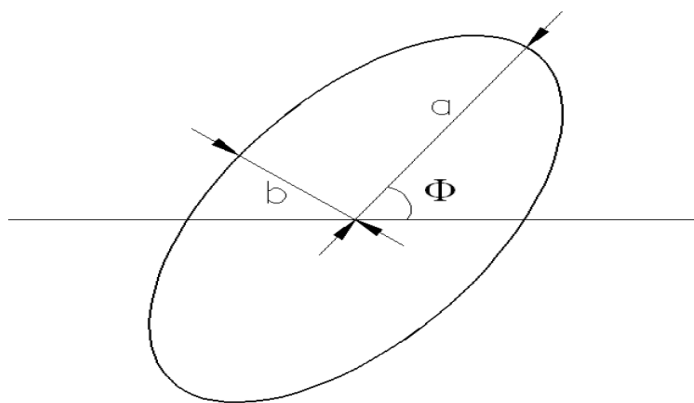

Notes: Chromaticity coordinate definition represents the projected performance at operating condition of 65°C.
Tolerance of measurements of the chromaticity Coordinate is ± 0.005
Chromaticity coordinates as per ANSI standard.

Typical Optical/Electrical Characteristics Graphs

Vf-----IF

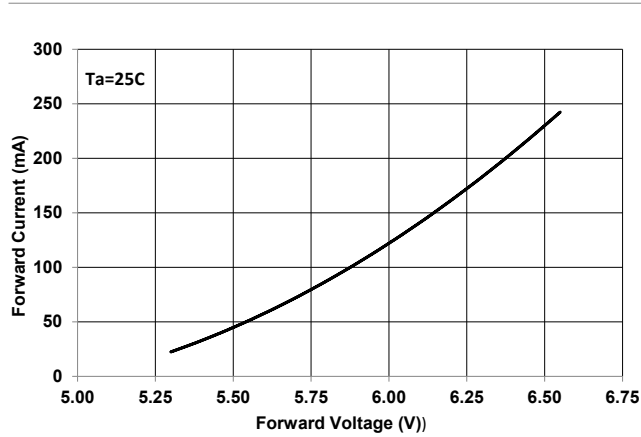

IF---- Relative Luminous flux

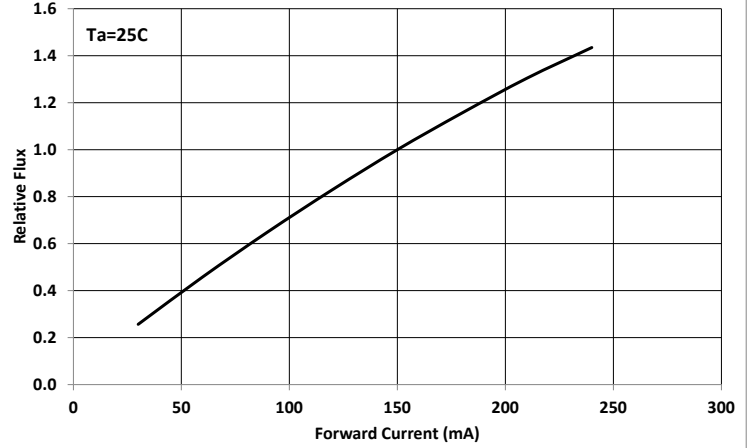

Tj-----Relative Luminous Flux

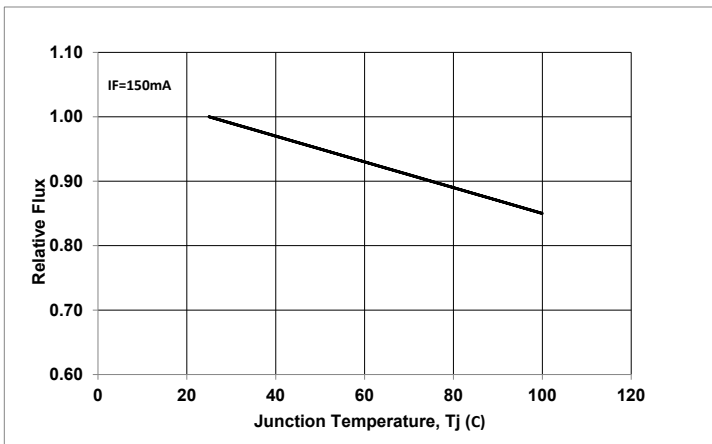

Wavelength- Relative Emission Intensity

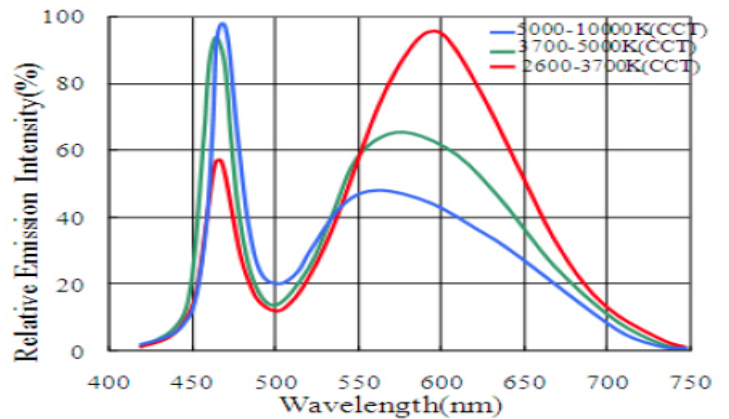

*Note: Luminus maintains a +/- 0.01 tolerance on chromaticity (CIEx and CIEy) measurements.

Typical Optical/Electrical Characteristics Graphs

Typical Polar Radiation Pattern

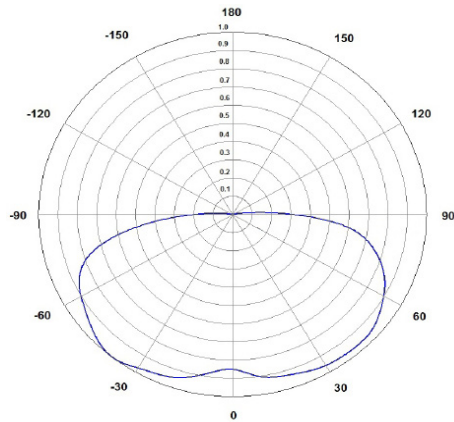

Tj -- Forward Voltage

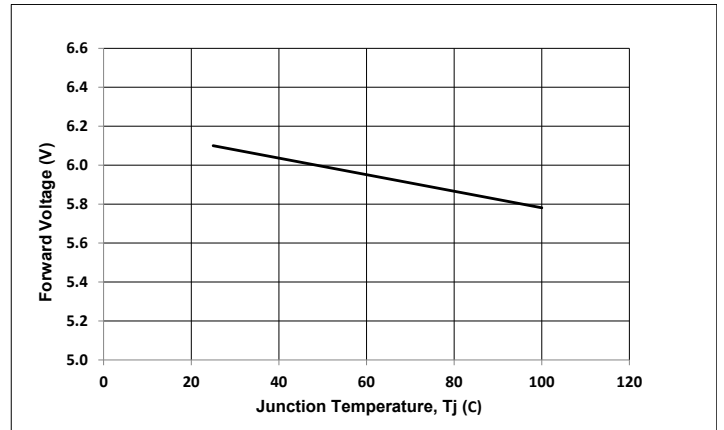

Chromaticity vs Temperature

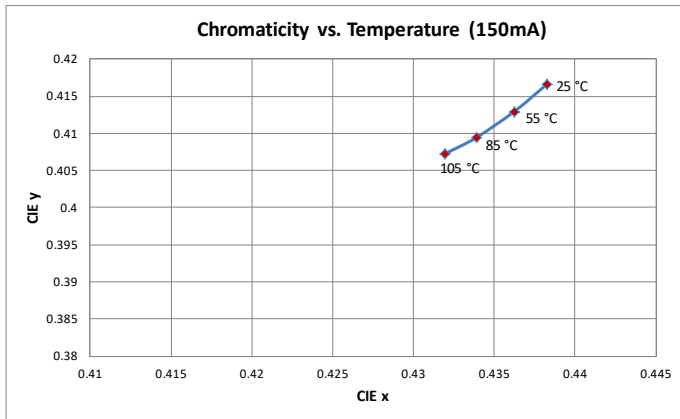

Chromaticity vs Current

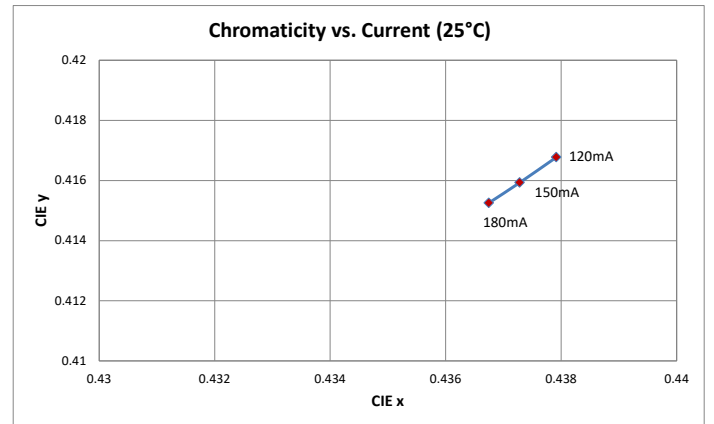

Current vs Tj

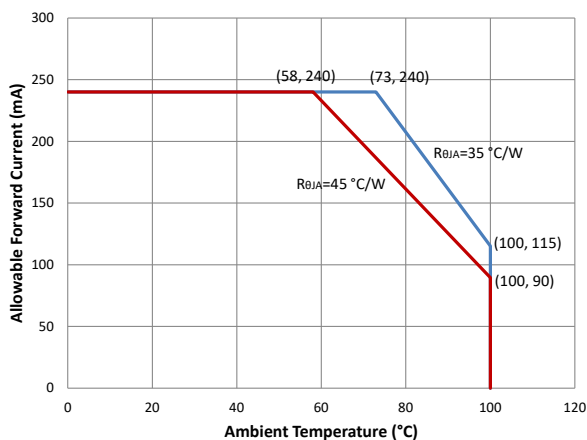

Product Ordering and Shipping Part Number Nomenclature

All XNOVA Cube products are packaged and labeled with part numbers as outlined in below. When shipped, each reel will contain only a single flux and voltage bin. The part number designation is as follows:

1616 XNOVA Cube LEDs

XNOVA Cube	Package Type	Package Configurator	Nominal CCT	Minimum CRI
MP	1616	2100	##	##

Example :

The part number MP-1616-2100-30-80 refers to a XNOVA Cube emitter with nominal color temperature of 3,000k, minimum CRI of 80 within a 3-step ellipse. Please refer to page 3 for a description of available CCT and CRI combinations. Standard products are delivered in a single 5 step MacAdam ellipse chromaticity bin. 3 step products are available as a special order with additional cost. To order 3 step product, please add a "-M3" suffix after the standard part number, for example, MP-1616-2100-30-80-M3. Please contact your local Luminus sales representative for pricing information.

Notes: CCT Codes:

27 = 2700 k
30 = 3000 k
35 = 3500k
40 = 4000 k
50 = 5000 k

CRI Codes:

80
90

Each mid power product shipped will be labeled with its specific flux and voltage bins. Not all bins listed are available in all CCTs and CRIs.

Luminus Flux Bins (Ta= 25°C)

Bin Code	Minimum Flux (Lumens)	Maximum Flux (Lumens)
F1	66	70
F2	70	74
F3	74	78
F4	78	82
F5	82	86
F6	86	90
F7	90	94
2A	94	100
2B	100	107
2C	107	114
2D	114	122
2E	122	130
2F	130	139

Forward Voltage Bins (Ta=25°C)

Bin Code	Minimum Voltage (Volts)	Maximum Voltage (Volts)
B	5.9	6.1
C	6.1	6.3
D	6.3	6.5
E	6.5	6.7
F	6.7	6.9

*Tolerance of measurements f the Forward Voltage is ±0.1V

Product Dimensions (mm)

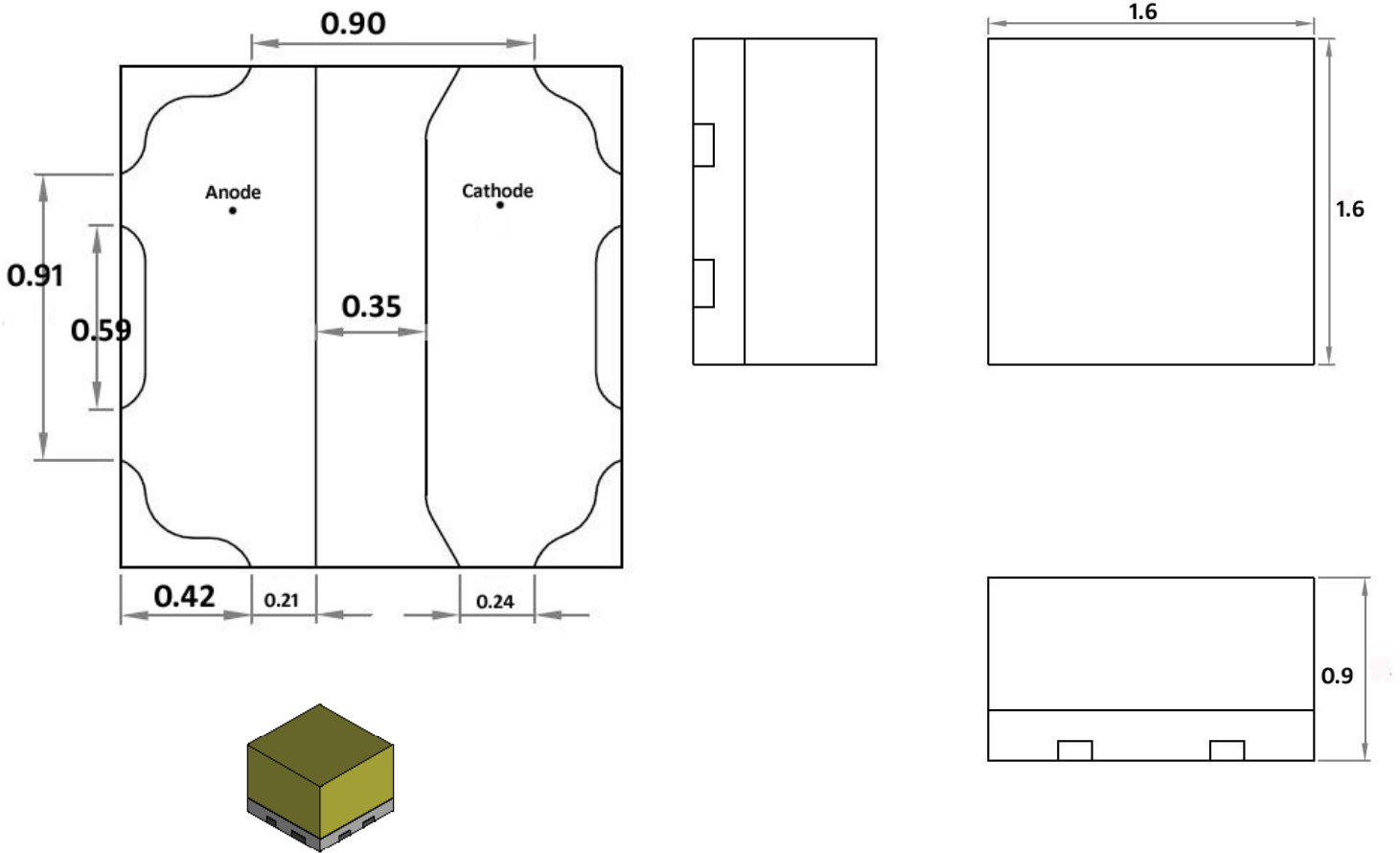

Recommended Soldering Pad Pattern

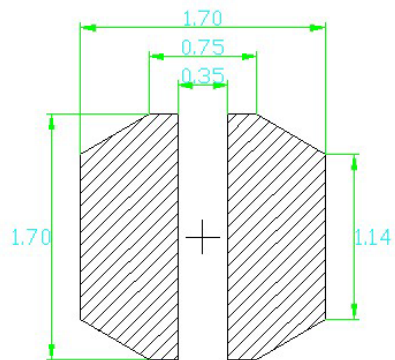

Recommended Solder Pad

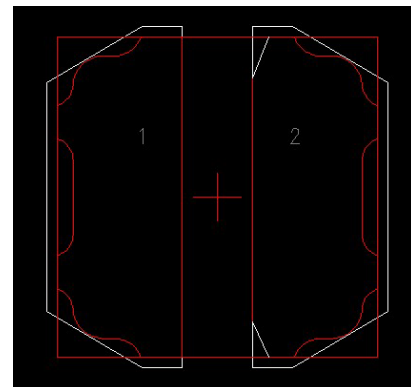

Effect Picture

- All dimensions are in millimeters.
- Scale : 1:1
- Undefined tolerance is $\pm 0.1\text{mm}$

Dimensions of tape (mm)

symbol	AO	BO	KO	PO	P1	P2
Spec	1.80±0.05	1.80±0.05	1.0±0.05	4.00±0.10	4.0±0.1	2.0±0.05
symbol	W	T	E	F	DO	D1
Spec	8.0±0.2	0.20±0.05	1.75±0.10	3.5±0.1	1.90+0.1/-0	1.90+0.1/-0

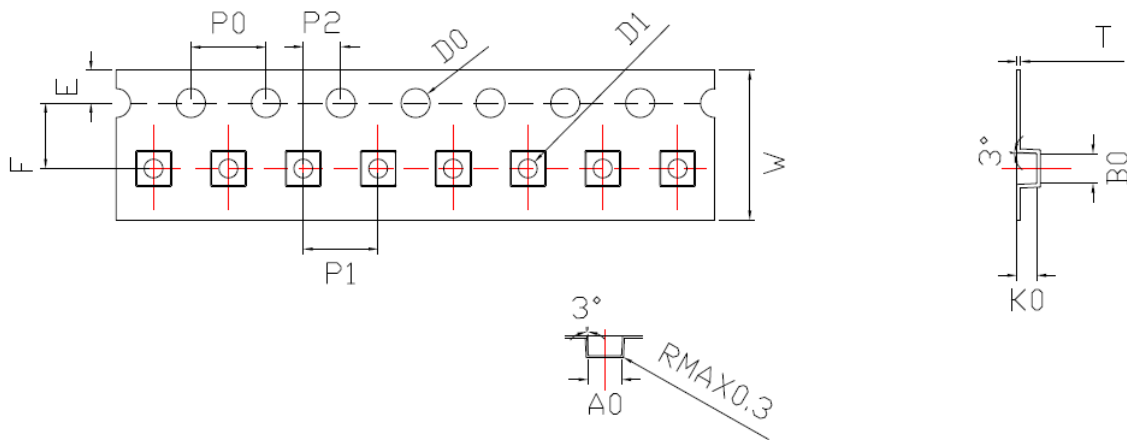

Reel Dimensions (mm)

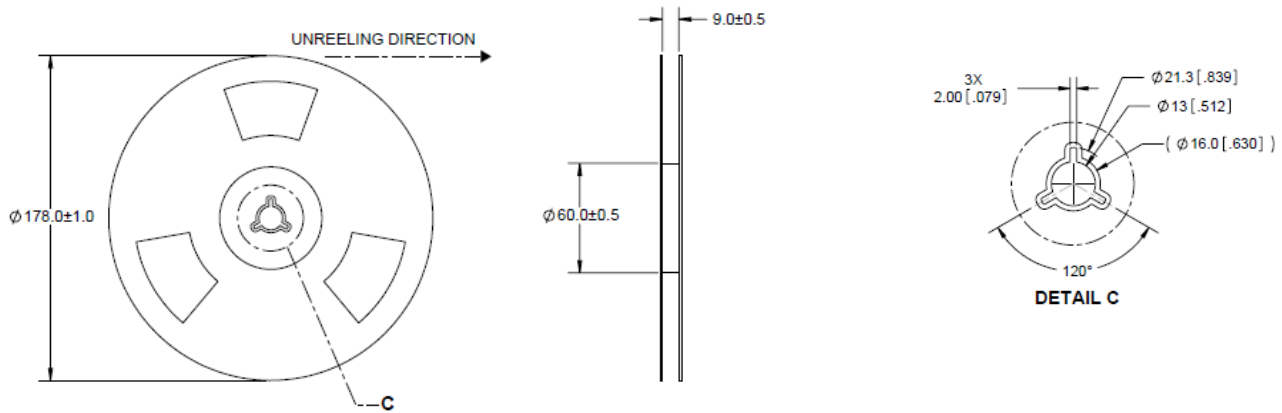

Reel Packaging

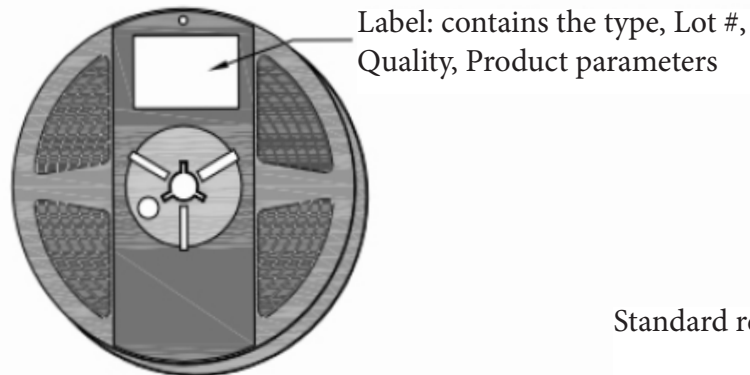

Standard reel quantity: 3000 pcs

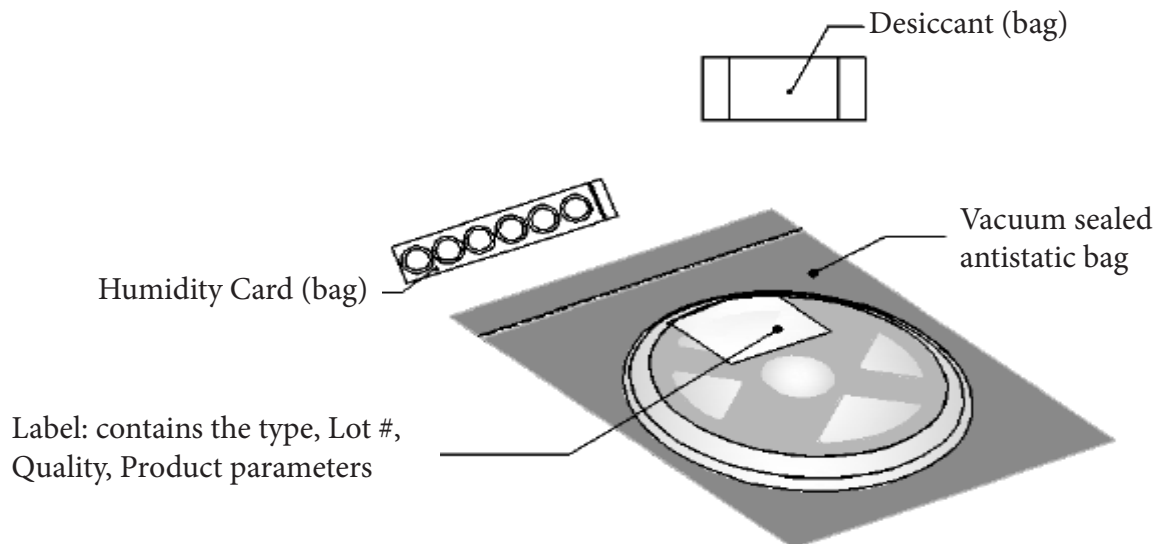

Box Packaging Information

*Capacity 5 reels per box

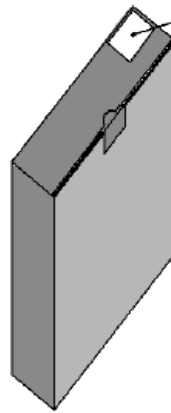

Label: contains the type,
Lot #, Quality, Product
parameters



*Capacity 10 reels per box



Label: contains the type,
Lot #, Quality, Product
parameters

Precaution for Use

Storage:

1. This device is rated at MSL 3 per JEDEC J-STD-020 standard.
2. Recommended storage condition:
At 5 °C- 30 °C and relative humidity 60% RH in its original package
3. After this bag is opened, devices that will be applied to infrared reflow, vapor - phase reflow, or equivalent soldering process must be:
 - a) Completed within 168 hours
 - b) Stored at less than 60%RH
 - c) If not completely used within 168 hours, seal the remaining in the moisture barrier bag
4. Devices require baking before mounting, if 3 a) is not met.
5. If baking is required, devices must be baked under below conditions:
24 hours at 60C+/-5C

Static Electricity:

1. The products are sensitive to static electricity, and care should be taken when handling them.
2. Static electricity or surge voltage will damage the LEDs. It is recommended to wear a anti-electrostatic wristband or an anti-electrostatic gloves when handling the LEDs.
3. All devices, equipment and machinery must be properly grounded. It is recommended that measures be taken against surge voltage to the equipment that mounts the LEDs.

Change of History

Date	Revision	Change Detail
6/28/2018	03	add m5 chromaticity coordinate