

# SFT-40-WxH

## High Power White LEDs

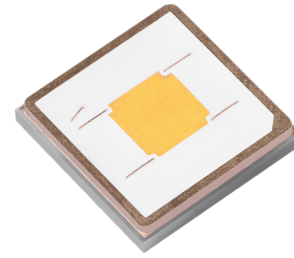

### Features

SFT white series is a powerful light source for beam pattern critical lighting applications. The flat window of an SFT white LED results in a much smaller light emitting surface than a dome-shaped cover, enabling smaller optics and higher optical efficiency in directional lighting systems.

- Vertical chip with high lumen density and small emitting angle, ideal for efficient optical beam shaping to achieve high intensity, narrow beam angle and long beam distance.
- Phosphor-on-chip with superior color uniformity over radiation angles, delivering homogeneous color in beam spots.
- Maximum Drive Current: 4 A
- Color Temperature: 2700K, 3000K
- Color Rendering Index: Min. 95
- Low thermal resistance: 0.7°C/W
- Electrically isolated thermal path
- 8 kV HBM ESD rating per ANSI/ESDA/JEDEC JS-001

### Applications

- Track Light
- Spotlight
- Wall Washer
- Task Light
- Downlight
- Broadcasting Light
- Stage and Studio Light
- Surgical Light

### Table of Contents

Ordering Information.....	2
Binning Structure.....	3
Absolute Maximum Ratings.....	6
Product Characteristics.....	6
Soldering Profile.....	9
Mechanical Dimensions.....	10
Tape and Reel Outline.....	11
Shipping Label.....	12
Packaging.....	13
Notes.....	14





## Ordering Information

### Ordering Part Numbers<sup>1</sup>

CRI	CCT	Luminous Flux		Chromaticity Bin Kit <sup>2</sup>	Ordering Part Number
		Minimum Flux Bin <sup>1</sup>	Minimum Flux $I_f=1500 \text{ mA}, T_j=85^\circ\text{C}$		
> 95	2700K	D7	355 lm	271	SFT-40-W27H-F50-D7271
				272	SFT-40-W27H-F50-D7272
		D8	375 lm	271	SFT-40-W27H-F50-D8271
				272	SFT-40-W27H-F50-D8272
	3000K	D8	375 lm	301	SFT-40-W30H-F50-D8301
				302	SFT-40-W30H-F50-D8302
		D9	395 lm	301	SFT-40-W30H-F50-D9301
				302	SFT-40-W30H-F50-D9302

### Part Number Nomenclature

SFT

40

W<xx>

F50

<ffccc>

Product Family	Chip Area	Color	Package Configuration	Bin Kit
<b>S:</b> Surface Mount <b>F:</b> Flat Window <b>T:</b> Single Emitter	<b>40:</b> 4.0 mm <sup>2</sup>	<b>W:</b> White <b>&lt;xx&gt;</b> Color Temperature <b>27:</b> 2700K <b>30:</b> 3000K <b>&lt;y&gt;</b> CRI Category Code <b>H:</b> CRI>95	<b>F50:</b> Package Code	<b>&lt;ff&gt;</b> Minimum Flux Bin, see 'Luminous Flux Binning' table for details <b>&lt;ccc&gt;</b> Chromaticity Bin Kit, see 'Chromaticity Bin Kit Codes' table for details

#### Note:

- The Ordering Part Number specifies the Minimum Flux Bin in shipment; higher flux bins may be shipped without advance notice. Please refer to 'Luminous Flux Binning' table for details of all flux bins.
- Shipments always adhere to the color bins specified in each Chromaticity Bin Kit. See 'Chromaticity Bin Kit Codes' table for the color bins included in each Bin Kit.



## Binning Structure

### Luminous Flux Binning<sup>1,2</sup>

Flux Bin Code	Binning @ 1500 mA			Correlated Minimum Flux (lm) @ T <sub>j</sub> =85°C <sup>2</sup>			
	T <sub>j</sub> = 85°C <sup>1</sup>		T <sub>j</sub> = 25°C				
	Minimum Flux (lm)	Maximum Flux (lm)	Minimum Flux (lm)	700 mA	2000 mA	3000 mA	4000 mA
D7	355	375	398	178	451	625	774
D8	375	395	420	188	476	660	818
D9	395	415	442	198	502	695	861
F1	415	440	465	208	527	730	905

### Forward Voltage Binning<sup>3</sup>

Voltage Bin Code <sup>3</sup>	Binning @ 1500 mA, T <sub>j</sub> = 85°C	
	Minimum Voltage (V)	Maximum Voltage (V)
VH	2.5	2.7
VJ	2.7	2.9
VK	2.9	3.1

**Note:**

- LEDs are measured at 25°C ambient temperature with 1.5 A 20 ms single pulse. The measured values are correlated to 1.5 A at 85°C junction temperature (T<sub>j</sub>). Luminus maintains a ±6% tolerance on flux measurement.
- Flux values at other junction temperature (T<sub>j</sub>) and/or forward current conditions are calculated and for reference only.
- Individual bins are not orderable.



## Binning Structure

### Chromaticity Binning Coordinates

CCT	Bin Code	CIE <sub>x</sub>	CIE <sub>y</sub>	Bin Code	CIE <sub>x</sub>	CIE <sub>y</sub>	Bin Code	CIE <sub>x</sub>	CIE <sub>y</sub>	Bin Code	CIE <sub>x</sub>	CIE <sub>y</sub>
2700K	JA1	0.4373	0.3893	JA2	0.4418	0.3981	JA3	0.4475	0.3994	JA4	0.4428	0.3906
		0.4418	0.3981		0.4465	0.4071		0.4523	0.4085		0.4475	0.3994
		0.4475	0.3994		0.4523	0.4085		0.4582	0.4099		0.4532	0.4008
		0.4428	0.3906		0.4475	0.3994		0.4532	0.4008		0.4483	0.3919
	JB1	0.4465	0.4071	JB2	0.4513	0.4164	JB3	0.4573	0.4178	JB4	0.4523	0.4085
		0.4513	0.4164		0.4562	0.4260		0.4624	0.4274		0.4573	0.4178
		0.4573	0.4178		0.4624	0.4274		0.4687	0.4289		0.4634	0.4193
		0.4523	0.4085		0.4573	0.4178		0.4634	0.4193		0.4582	0.4099
	JC1	0.4582	0.4099	JC2	0.4634	0.4193	JC3	0.4695	0.4207	JC4	0.4641	0.4112
		0.4634	0.4193		0.4687	0.4289		0.4750	0.4304		0.4695	0.4207
		0.4695	0.4207		0.4750	0.4304		0.4813	0.4319		0.4756	0.4221
		0.4641	0.4112		0.4695	0.4207		0.4756	0.4221		0.4700	0.4126
	JD1	0.4483	0.3919	JD2	0.4532	0.4008	JD3	0.4589	0.4021	JD4	0.4538	0.3931
		0.4532	0.4008		0.4582	0.4099		0.4641	0.4112		0.4589	0.4021
		0.4589	0.4021		0.4641	0.4112		0.4700	0.4126		0.4646	0.4034
		0.4538	0.3931		0.4589	0.4021		0.4646	0.4034		0.4593	0.3944
3000K	HA1	0.4147	0.3814	HA2	0.4183	0.3898	HA3	0.4242	0.3919	HA4	0.4203	0.3833
		0.4183	0.3898		0.4221	0.3984		0.4281	0.4006		0.4242	0.3919
		0.4242	0.3919		0.4281	0.3919		0.4342	0.4028		0.4300	0.3939
		0.4203	0.3833		0.4242	0.4073		0.4300	0.3939		0.4259	0.3853
	HB1	0.4221	0.3984	HB2	0.4259	0.4006	HB3	0.4322	0.4096	HB4	0.4281	0.4006
		0.4259	0.4073		0.4299	0.4165		0.4364	0.4188		0.4322	0.4096
		0.4322	0.4096		0.4364	0.4188		0.4430	0.4212		0.4385	0.4119
		0.4281	0.4028		0.4322	0.4096		0.4385	0.4119		0.4342	0.4028
	HC1	0.4342	0.4119	HC2	0.4385	0.4119	HC3	0.4449	0.4141	HC4	0.4403	0.4049
		0.4385	0.4141		0.4430	0.4212		0.4496	0.4236		0.4449	0.4141
		0.4449	0.4049		0.4496	0.4236		0.4562	0.4260		0.4513	0.4164
		0.4403	0.3853		0.4449	0.4141		0.4513	0.4164		0.4465	0.4071
	HD1	0.4259	0.3939	HD2	0.4300	0.3939	HD3	0.4359	0.3960	HD4	0.4316	0.3873
		0.4300	0.3960		0.4342	0.4028		0.4403	0.4049		0.4359	0.3960
		0.4359	0.3873		0.4403	0.4049		0.4465	0.4071		0.4418	0.3981
		0.4316	0.4006		0.4359	0.3960		0.4418	0.3981		0.4373	0.3893



## Binning Structure

Chromaticity Binning Diagram<sup>1,2</sup>

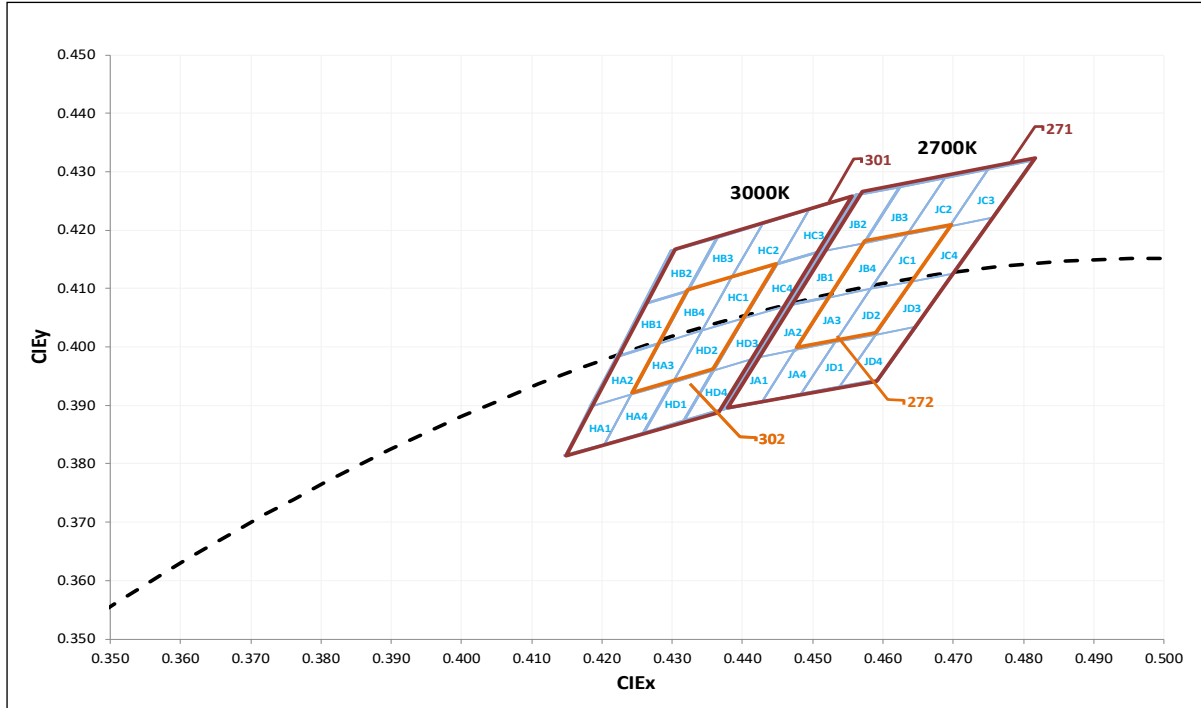

Chromaticity Bin Kit Codes

CCT	Bin Kit	Chromaticity Bins
2700K	271	JA1, JA2, JA3, JA4, JB1, JB2, JB3, JB4, JC1, JC2, JC3, JC4, JD1, JD2, JD3, JD4
	272	JA3, JB4, JC1, JD2
3000K	301	HA1, HA2, HA3, HA4, HB1, HB2, HB3, HB4, HC1, HC2, HC3, HC4, HD1, HD2, HD3, HD4
	302	HA3, HB4, HC1, HD2

**Note:**

- LED chromaticity is measured and binned at 25°C ambient temperature with 1500 mA 20 ms single pulse.
- Luminus maintains a tolerance of  $\pm 0.005$  on Chromaticity (CIE<sub>x</sub>, CIE<sub>y</sub>) measurement.



## Absolute Maximum Ratings

		Symbol	Values	Unit
DC Forward Current	Minimum	$I_{f\ min}$	0.1	A
	Maximum	$I_{f\ max}$	4	
Surge Current ( $t < 10\ ms$ , Duty Cycle $< 10\%$ )		$I_{s\ max}$	10	A
Reverse Voltage (@ $I_f = 10\ mA$ )		$V_r$	5	V
Power Dissipation		$P_D$	13	W
Operating Temperature		$T_{opr}$	-40 to 100	°C
Storage Temperature		$T_{stg}$	-40 to 100	°C
Junction Temperature		$T_{j\ max}$	150	°C
ESD withstand Voltage HBM Per ANSI/ESDA/JEDEC JS-001		$V_{HBM}$	8	kV
ESD withstand Voltage CDM Per ANSI/ESDA/JEDEC JS-002		$V_{CDM}$	1	kV

## Product Characteristics

Parameter		Symbol	Value	Unit
Color Rendering Index <sup>1</sup> ( $T_j = 85^\circ\text{C}$ )		CRI	>95	
Color Rendering, R9 ( $T_j = 85^\circ\text{C}$ )		$R9_{\min}$	>50	
Viewing Angle (FWHM)		$2\theta_{1/2}$	120°	
Forward Voltage ( $I_f = 1500\ mA$ , $T_j = 85^\circ\text{C}$ )	Minimum	$V_{f\ min}$	2.5	V
	Typical	$V_{f\ typ}$	2.8	
	Maximum	$V_{f\ max}$	3.1	
Temperature Coefficient of Voltage		$\partial V_f / \partial T$	-1.2	mV/°C
Thermal Resistance (Electrical) Junction/Solder Point		$R_{thjs-EL}$	0.7	°C/W

**Note:**

1. Luminus maintains a tolerance of  $\pm 2$  on Color Rendering Index (CRI) measurement.



### Relative Luminous Flux

Forward Current:  $\phi_v/\phi_v(1.5\text{ A}), T_j = 85^\circ\text{C}$

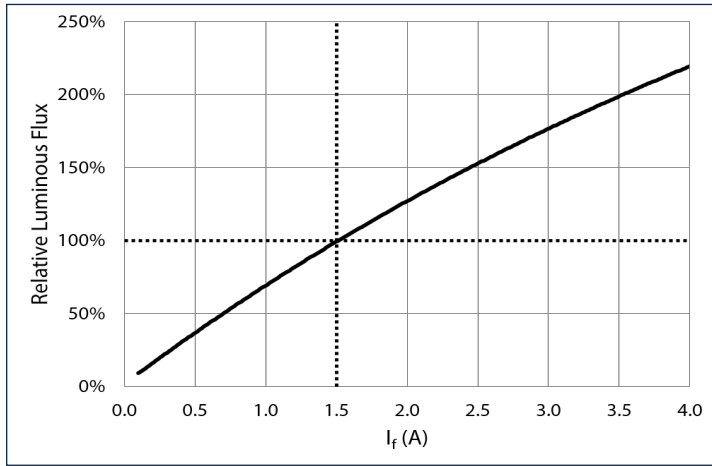

Temperature ( $T_j$ ):  $\phi_v/\phi_v(85^\circ\text{C}), I_f = 1.5\text{ A}$

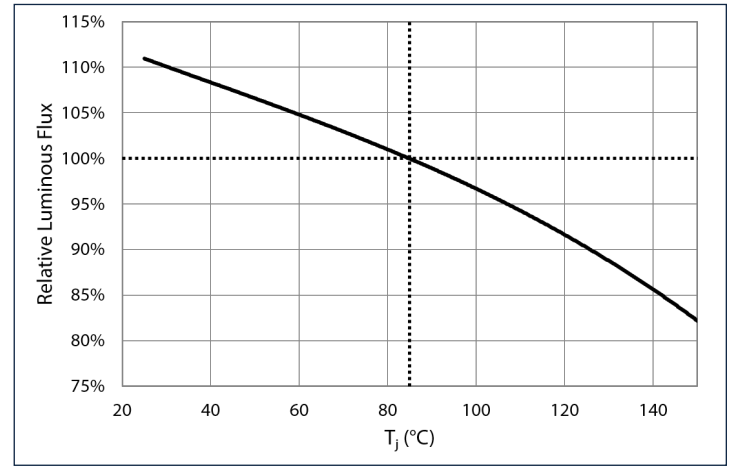

### Forward Voltage

Forward Current:  $\Delta V_f = V_f(I_f) - V_f(1.5\text{ A}), T_j = 85^\circ\text{C}$

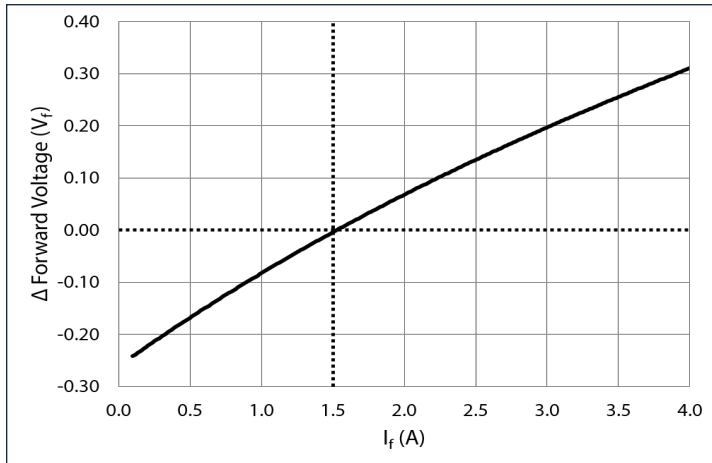

Temperature ( $T_j$ ):  $\Delta V_f = V_f(T_j) - V_f(85^\circ\text{C}), I_f = 1.5\text{ A}$

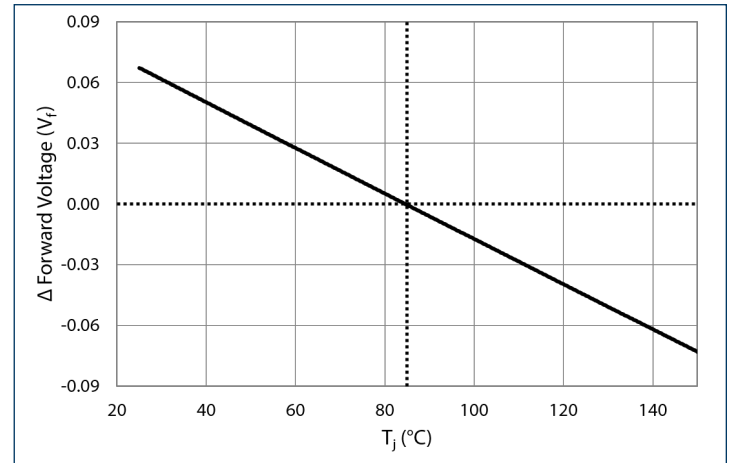

### Relative Chromaticity

Forward Current:  $\Delta \text{CIEx}, \Delta \text{CIEy} = \text{CIEx}, \text{y}(I_f) - \text{CIEx}, \text{y}(1.5\text{ A}), T_j = 85^\circ\text{C}$

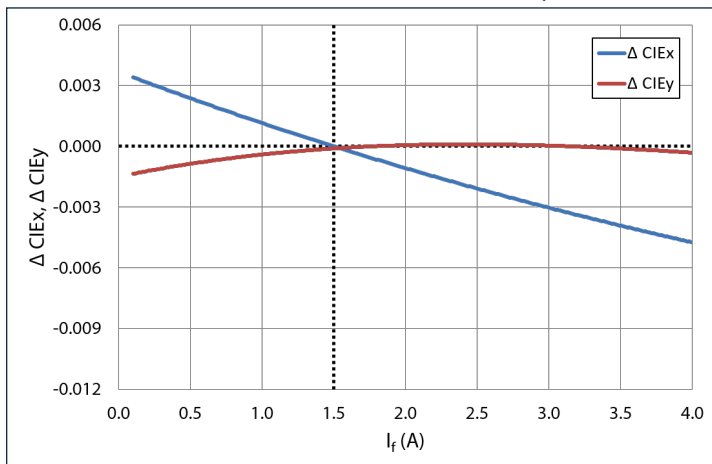

Temperature ( $T_j$ ):  $\Delta \text{CIEx}, \Delta \text{CIEy} = \text{CIEx}, \text{y}(T_j) - \text{CIEx}, \text{y}(25^\circ\text{C}), I_f = 1.5\text{ A}$

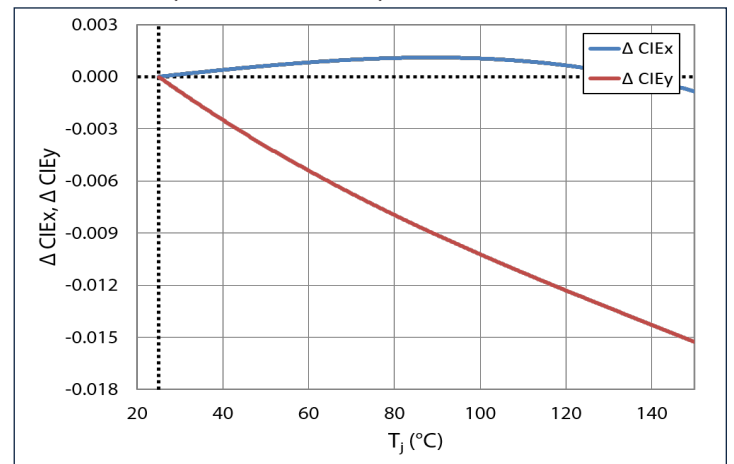



### Angular Distribution

$I_f = 1.5 \text{ A}; T_j = 25^\circ\text{C}$

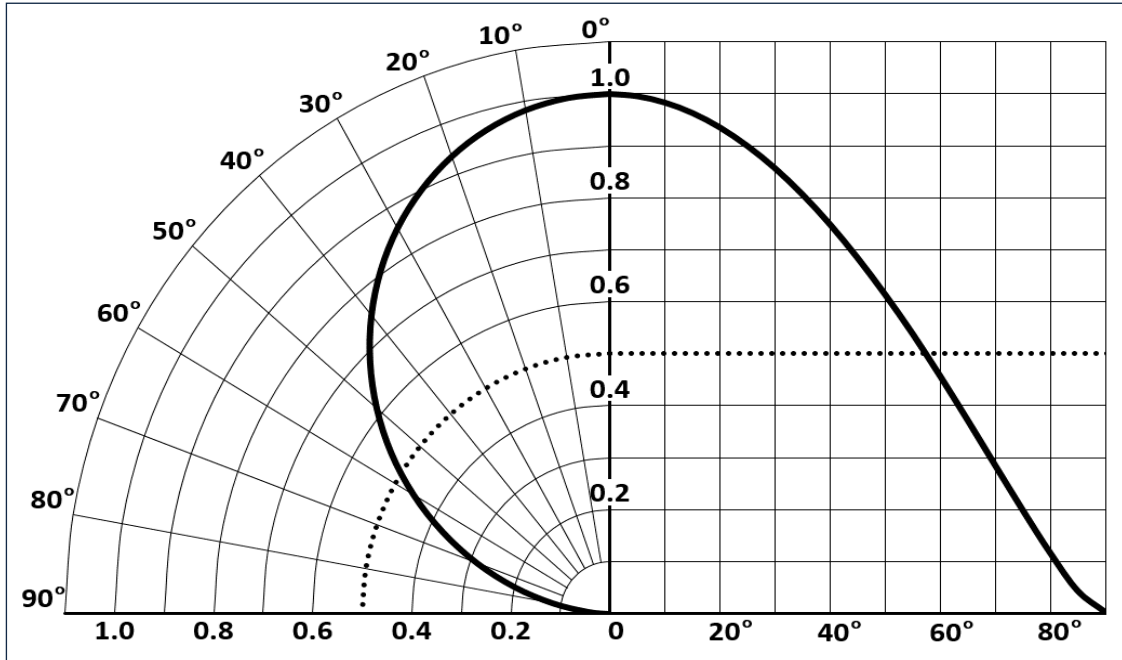

### Relative Spectral Power Distribution

$I_f = 1.5 \text{ A}; T_j = 85^\circ\text{C}$

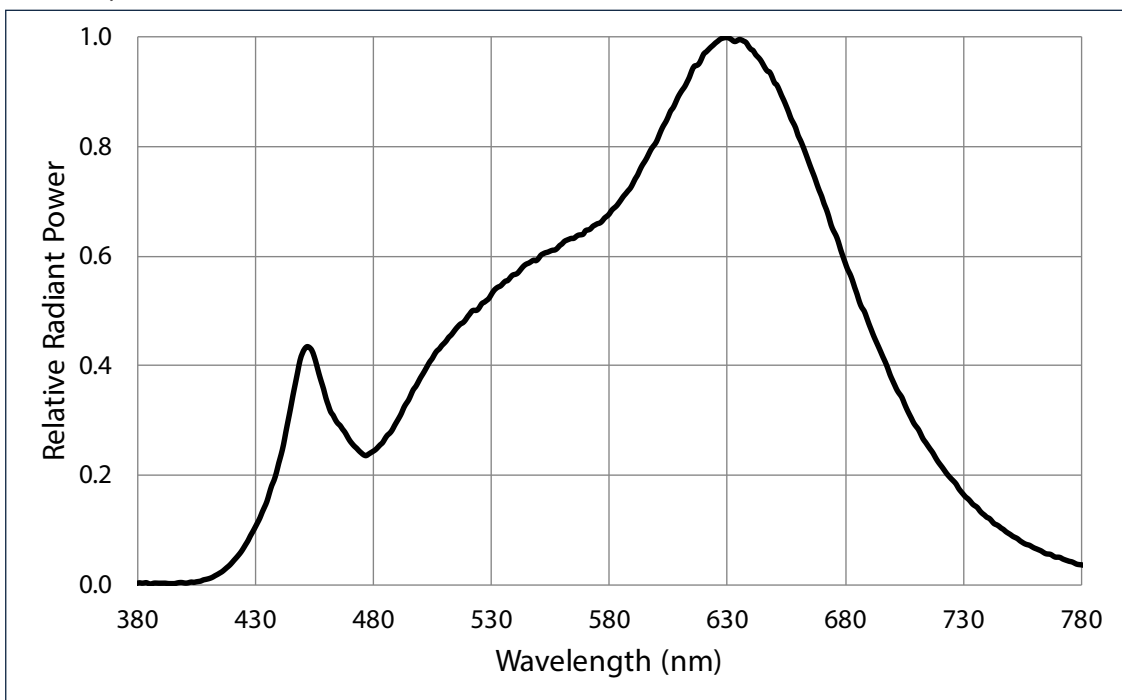





## Soldering Profile

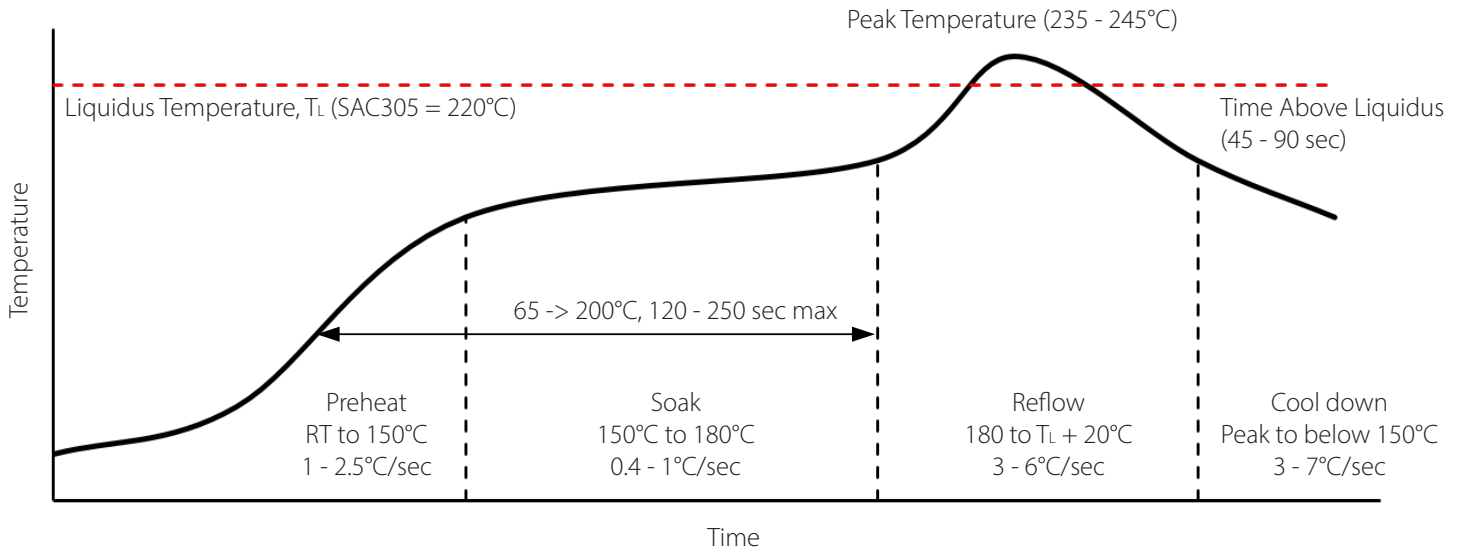

SMT Rework Guideline	Manual Hotplate Reflow	Hot Air Gun Reflow
Heating Time	< 60 sec	
Hotplate Temperature	< 245°C	< 150°C

**Note:**

- Product complies to Moisture Sensitivity Level 3 (MSL 3).
- The numbers in the table are specific to SAC305. Luminus recommends using an SAC305 solder paste with a no-clean flux for RoHS compliant products.
- During the pick and place process, axial forces on the dome (or window) should not exceed 0.5 Newtons (N).
- Use of a multi-zone IR reflow oven with a nitrogen blanket is recommended.
- Time-temperature profile of the reflow process showing the four functional profile zones are defined in IPC-7801. Temperature is referenced to the center of the PCB.
- Luminus recommends to use the solder paste data sheet information as a starting point in time-temperature process development.
- These are general guidelines. Consult the solder paste manufacturer's datasheet for guidelines specific to the alloy and flux combination used in your application.  
For more information, please refer to:  
<https://luminusdevices.zendesk.com/hc/en-us/articles/360060306692-How-do-I-Reflow-Solder-Luminus-SMD-Components->
- For any technical questions about soldering process, please contact Luminus at techsupport@luminus.com.



## Mechanical Dimensions<sup>1</sup>

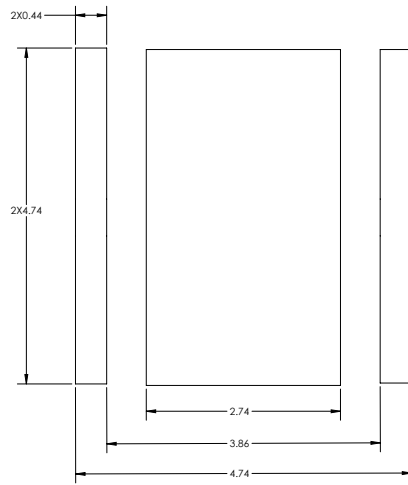
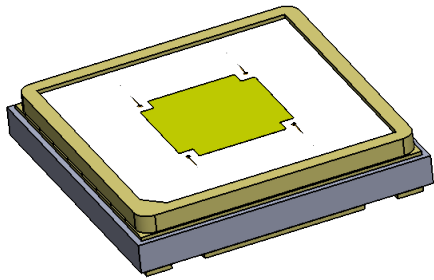
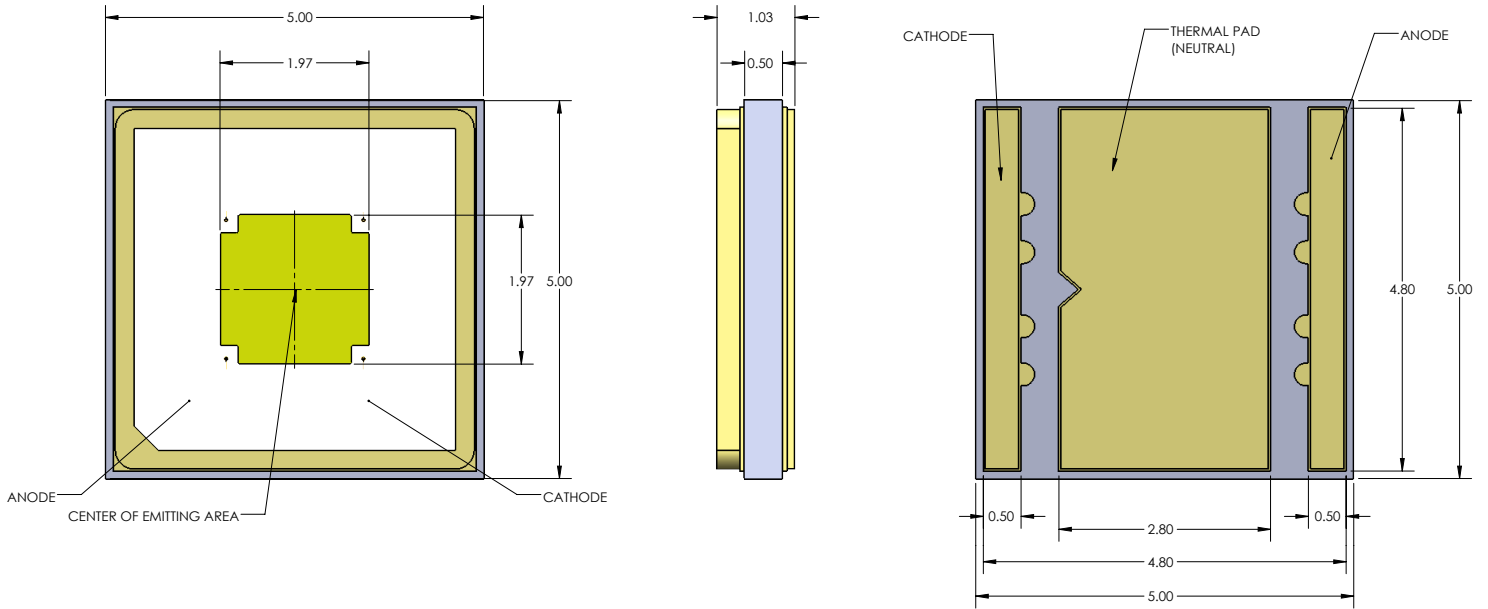

RECOMMENDED PCB SOLDER PAD

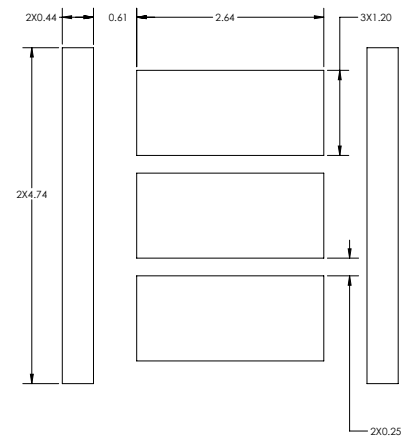

RECOMMENDED Stencil Pattern

**Note:**

1. All dimensions are in millimeter  $\pm 0.13$  mm.



## Tape and Reel Outline

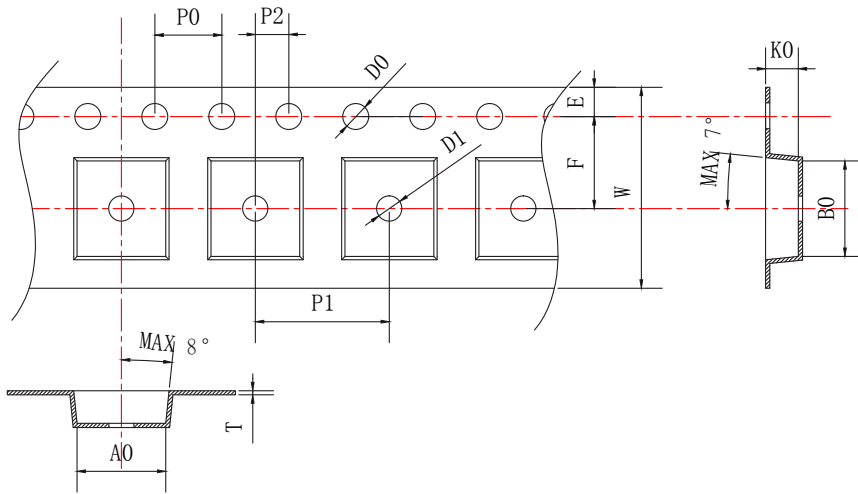

Parameter	Dimension (mm)
A0	5.3±0.1
B0	5.3±0.1
D0	1.5±0.1
D1	1.5±0.25
E	1.75±0.1
F	5.5±0.1
K0	1.7±0.1
P0	4.0±0.1
P1	8.0±0.1
P2	2.0±0.1
T	0.25±0.02
W	12+0.3 12-0.1

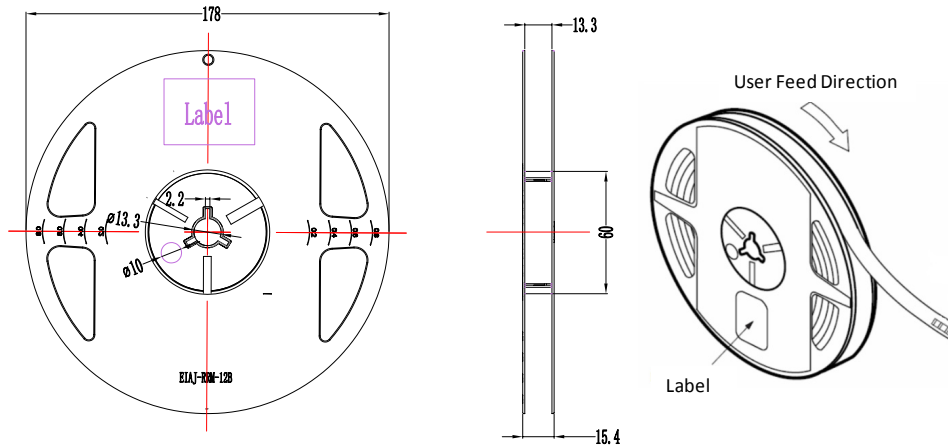

### Note:

1. Each Reel contains 500 units of LEDs.
2. Black anti-static tape material (Denka ECM3/ECAP3).
3. The accumulated tolerance for ten chain holes should be no more than 0.2 mm.
4. The tortuosity of 250 mm tape should be no more than 1 mm.
5. Leave 800 mm of type empty for lead in (100 empty pockets).
6. Leave 1200 mm of type empty for trailer (150 empty pockets).
7. All dimensions must comply to EIA-481-D.
8. Final tape and reel packaging must meet the requirements of JEDEC-STD-033, LEVEL 2A.



## Shipping Label

### Label on Packaging Box

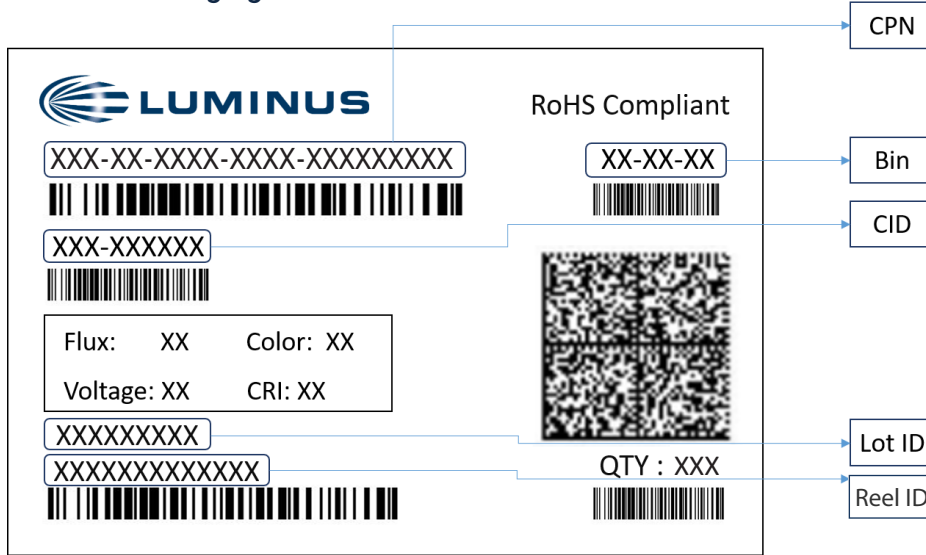

#### Label Fields:

- CPN:** Luminus ordering part number
- CID:** Customer's part number
- QTY:** Quantity of parts per reel
- Flux:** Bin as defined on page 3
- Voltage:** Bin as defined on page 3
- Color:** Bin as defined on page 4
- CRI:** NA
- Lot ID & Reel ID:** For Luminus internal use

### Label on Reel

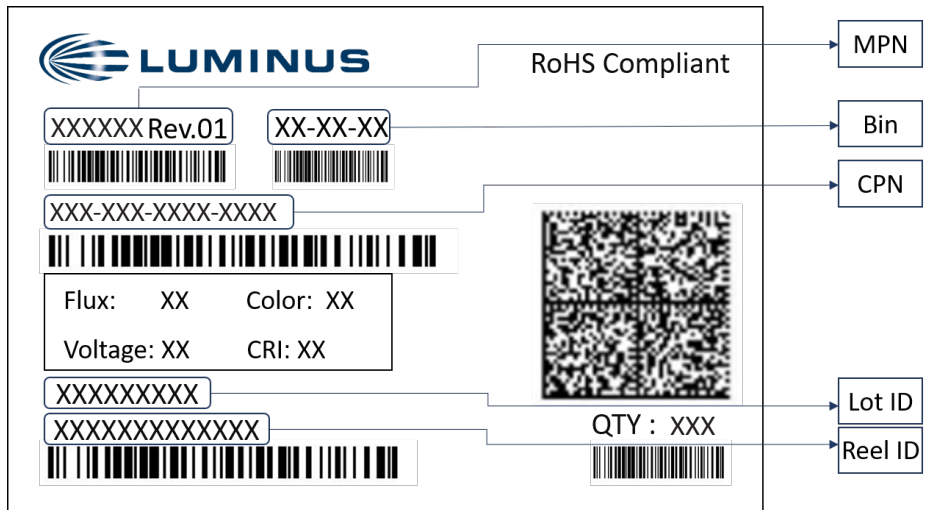

#### Label Fields:

- CPN:** Luminus ordering part number
- MPN:** For Luminus internal use
- QTY:** Quantity of parts per reel
- Flux:** Bin as defined on page 3
- Voltage:** Bin as defined on page 3
- Color:** Bin as defined on page 4
- CRI:** NA
- Lot ID & Reel ID:** For Luminus internal use



## Packaging

### Packaged Reel

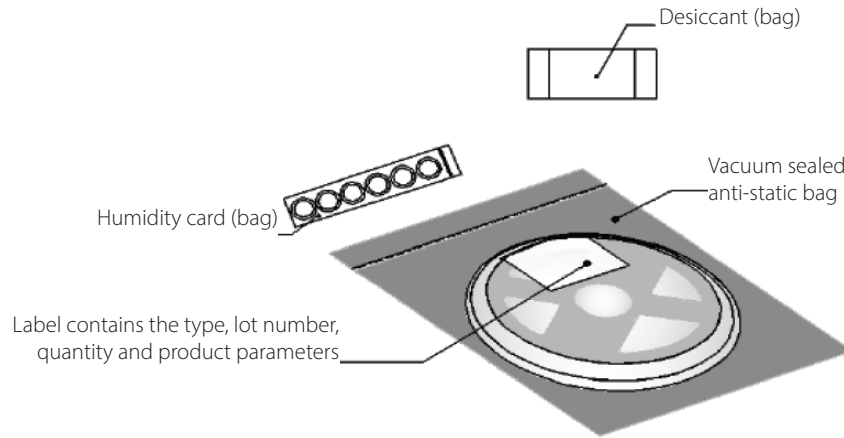

### Packaging boxes

**Box Size 1** - 5 reels per box  
Size: 22.5 x 24.5 x 6.5 cm

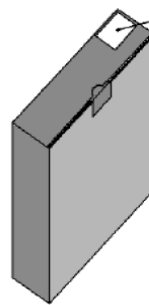
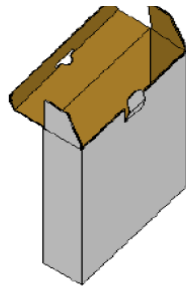

Label contains the type, lot number, quantity and product parameters

\*Capacity 5 reels per box

**Box Size 2** - 10 reels per box  
Size: 22.5 x 24.5 x 13 cm

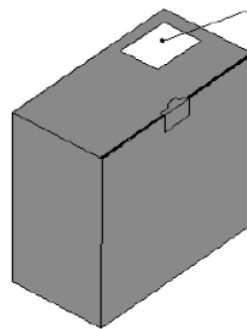
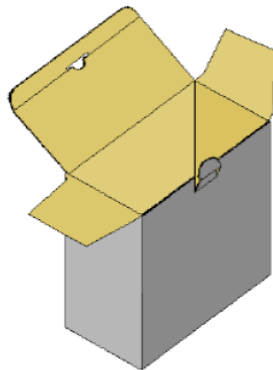

Label contains the type, lot number, quantity and product parameters

\*Capacity 10 reels per box

### Packing Configuration:

- 500 units per reel
- Each reel is enclosed in anti-static bag
- Shipping label is placed on top of each reel
- Multiple labels are attached to the box (one label per reel inside the box)



## Notes

### Static Electricity

1. The products are sensitive to static electricity, and care should be taken when handling them.
2. Static electricity or surge voltage will damage the LEDs. It is recommended to wear anti-electrostatic gloves or wristband when handling the LEDs.
3. All devices, equipment and machinery must be properly grounded. It is recommended that measures be taken against surge voltage to the equipment that mounts the LEDs.

Reference: [APN-002815](#) Electrical Stress Damage to LEDs and How to Prevent It

### Storage

1. Before opening the package

The LEDs should be kept at a temperature lower than 40°C and relative humidity lower than 90%. The LEDs should be used within a year. When storing the LEDs, moisture proof package with absorbent material (silica gel) is recommended.

2. After opening the package

The LEDs should be kept at a temperature lower than 30°C and relative humidity lower than 60%. The LEDs should be soldered within 168 hours (7 days) after opening the moisture proof package.

If unused LEDs remain, they should be stored in moisture proof packages, such as sealed containers with moisture absorbent material (silica gel). It is also recommended to return the unused LEDs to the original moisture proof package and to seal it again.

If the moisture absorbent material (silica gel) vaporizes or passes the expiration date, baking treatment should be performed by using the following conditions : 60°C for 20 hours.

The LED's electrode and lead frame comprise a silver plated copper alloy. The silver surface may be affected by environments. Please avoid conditions which may cause the LEDs to corrode or discolor. The corrosion or discoloration might lower solderability or affect optical characteristics.

Please avoid rapid transition in ambient temperature, especially in high humidity environments where condensation can occur.