

SST-20-WF (CRI > 80)

High Power White LEDs

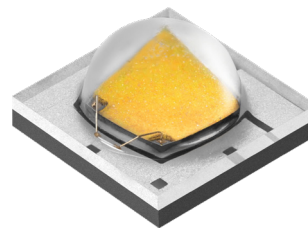

Features

- High-efficacy white LEDs for high-performance indoor and outdoor directional lighting applications.
- The vertical chip features high lumen density and small emitting angle, ideal for maximizing the light intensity and reducing the optics size in optical beam shaping.
- The phosphor-on-chip technology delivers high color uniformity over radiation angle, enabling superior light quality for beam spots.
- LM-80 10,000-hr test data available, excellent TM-21 lifetime and color stability.
- Maximum Drive Current: 2.0 A
- Color Temperature: 3000K - 6500 K
- Color Rendering Index: > 80
- Low thermal resistance: 1.6°C/W
- ANSI-compatible chromaticity bins
- Electrically isolated thermal path
- 8 kV HBM ESD rating per ANSI/ESDA/JEDEC JS-001



Applications

- Roadway and Street Lighting
- Sports Field Lighting
- Outdoor Area Lighting
- Landscape Lighting
- Garage and Canopy Lights
- High / Low Bay Industrial Lighting
- Miniature Recessed Lights
- Wall Washer
- Track Light
- Spotlight

Table of Contents

Ordering Information.....	2
Binning Structure.....	4
Absolute Maximum Ratings.....	7
Product Characteristics.....	7
Soldering Profile.....	11
Mechanical Dimensions.....	12
Tape and Reel Outline.....	14
Shipping Label.....	15
Packaging.....	16
Notes.....	17



Ordering Information

Ordering Part Numbers¹

CRI	CCT	Luminous Flux		Solder Pad Type ³	Ordering Part Numbers
		Minimum Flux Bin ¹	Minimum Flux ²		Chromaticity Bin Kit ANSI Centers ⁴
> 80	3000K	D2	280 lm	A	SST-20-WF30-A2-D2302
				B	SST-20-WF30-B2-D2302
		D3	295 lm	A	SST-20-WF30-A2-D3302
				B	SST-20-WF30-B2-D3302
	4000K	D3	295 lm	A	SST-20-WF40-A2-D3402
				B	SST-20-WF40-B2-D3402
		D4	310 lm	A	SST-20-WF40-A2-D4402
				B	SST-20-WF40-B2-D4402
	5000K	D3	295 lm	A	SST-20-WF50-A2-D3502
				B	SST-20-WF50-B2-D3502
		D4	310 lm	A	SST-20-WF50-A2-D4502
				B	SST-20-WF50-B2-D4502
	5700K	D3	295 lm	A	SST-20-WF57-A2-D3572
				B	SST-20-WF57-B2-D3572
		D4	310 lm	A	SST-20-WF57-A2-D4572
				B	SST-20-WF57-B2-D4572
	6500K	D3	295 lm	A	SST-20-WF65-A2-D3652
				B	SST-20-WF65-B2-D3652
		D4	310 lm	A	SST-20-WF65-A2-D4652
				B	SST-20-WF65-B2-D4652

Note:

- The Ordering Part Number specifies the Minimum Flux Bin in shipment; higher flux bins may be shipped without advance notice. Please refer to 'Luminous Flux Binning' table for details of all flux bins.
- Product test condition: $I_f = 700 \text{ mA}$, $T_j = 85^\circ\text{C}$.
- See 'Mechanical Dimensions' for A and B types' solder pad configurations. All product mechanical, electrical and optical specifications are otherwise identical.
- Shipments always adhere to the color bins specified in each Chromaticity Bin Kit. See 'Chromaticity Bin Kit Codes' table for the color bins included in each Bin Kit.



Ordering Information

Part Number Nomenclature

SST

20

W<yxx>

<p#>

<ffccc>

Product Family	Chip Area	Color	Package Configuration	Bin Kit
S: Surface Mount S: Dome Lensed T: Single Emitter	20: 2.0 mm ²	W: White <y> CRI Category Code F: CRI > 80 <xx> Color Temperature 30: 3000K 65: 6500K	<p> Solder Pad Configuration A: type A - see page 12 B: type B - see page 13 <#> Chip Generation 2: Gen 2	<ff> Minimum Flux Bin, see 'Luminus Flux Binning' table for details <ccc> Chromaticity Bin Kit, see 'Chromaticity Bin Kit Codes' table for details



Binning Structure

Luminous Flux Binning^{1,2}

Flux Bin Code	Binning @ 700 mA			Correlated Minimum Flux (lm) @ $T_j=85^{\circ}\text{C}^2$			
	$T_j=85^{\circ}\text{C}$		$T_j=25^{\circ}\text{C}$				
	Minimum Flux (lm)	Maximum Flux (lm)	Minimum Flux (lm)	350 mA	1000 mA	1500 mA	2000 mA
D2	280	295	308	151	381	535	672
D3	295	310	325	159	401	563	708
D4	310	325	341	167	422	592	744
D5	325	340	358	176	442	621	780
D6	340	355	374	184	462	649	816

Forward Voltage Binning³

Voltage Bin Code ³	Binning @ 700 mA, $T_j=85^{\circ}\text{C}$	
	Minimum Voltage (V)	Maximum Voltage (V)
VH	2.5	2.7
VJ	2.7	2.9
VK	2.9	3.1

Note:

- LEDs are measured at 25°C ambient temperature with 700 mA 20 ms single pulse. The measured values are correlated to values at 85°C junction temperature (T_j). Luminus maintains a $\pm 6\%$ tolerance on flux measurement.
- Flux values at other junction temperature (T_j) and/or forward current conditions are calculated and for reference only.
- Individual voltage bins are not orderable.



Binning Structure

Chromaticity Binning Coordinates

CCT	Bin Code	CIE _x	CIE _y	Bin Code	CIE _x	CIE _y	Bin Code	CIE _x	CIE _y	Bin Code	CIE _x	CIE _y
3000K	HA3	0.4242	0.3919	HB4	0.4281	0.4006	HC1	0.4342	0.4119	HD2	0.4300	0.3939
		0.4281	0.4006		0.4322	0.4096		0.4385	0.4141		0.4342	0.4028
		0.4342	0.4028		0.4385	0.4119		0.4449	0.4049		0.4403	0.4049
		0.4300	0.3939		0.4342	0.4028		0.4403	0.3853		0.4359	0.3960
4000K	FA3	0.3744	0.3685	FB4	0.3763	0.3760	FC1	0.3825	0.3798	FD2	0.3804	0.3721
		0.3763	0.3760		0.3782	0.3837		0.3847	0.3877		0.3825	0.3798
		0.3825	0.3798		0.3847	0.3877		0.3912	0.3917		0.3887	0.3836
		0.3804	0.3721		0.3825	0.3798		0.3887	0.3836		0.3863	0.3758
5000K	DA	0.3371	0.3490	DB	0.3376	0.3616	DC	0.3463	0.3687	DD	0.3451	0.3554
		0.3451	0.3554		0.3463	0.3687		0.3551	0.3760		0.3533	0.3620
		0.3440	0.3427		0.3451	0.3554		0.3533	0.3620		0.3515	0.3487
		0.3366	0.3369		0.3371	0.3490		0.3451	0.3554		0.3440	0.3427
5700K	CA	0.3215	0.3350	CB	0.3207	0.3462	CC	0.3290	0.3538	CD	0.3290	0.3417
		0.3290	0.3417		0.3290	0.3538		0.3376	0.3616		0.3371	0.3490
		0.3290	0.3300		0.3290	0.3417		0.3371	0.3490		0.3366	0.3369
		0.3222	0.3243		0.3215	0.3350		0.3290	0.3417		0.3290	0.3300
6500K	BA	0.3048	0.3207	BB	0.3028	0.3304	BC	0.3115	0.3391	BD	0.3130	0.3290
		0.3130	0.3290		0.3115	0.3391		0.3205	0.3481		0.3213	0.3373
		0.3144	0.3186		0.3130	0.3290		0.3213	0.3373		0.3221	0.3261
		0.3068	0.3113		0.3048	0.3207		0.3130	0.3290		0.3144	0.3186



Binning Structure

Chromaticity Binning Diagram¹

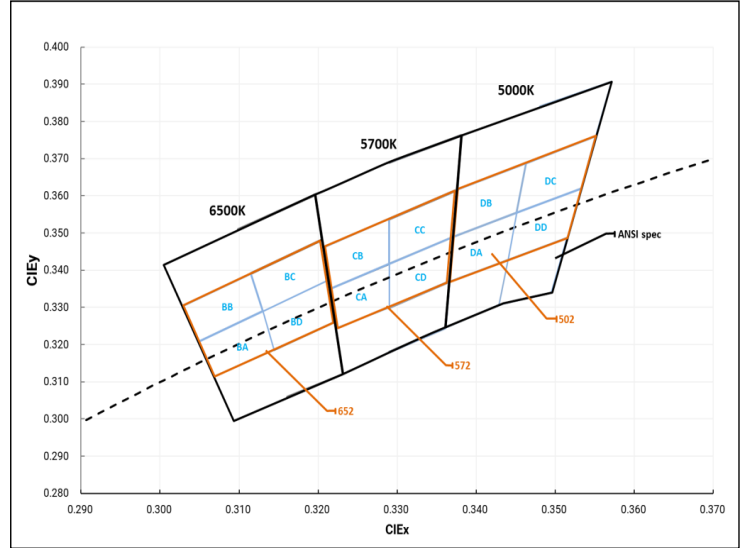
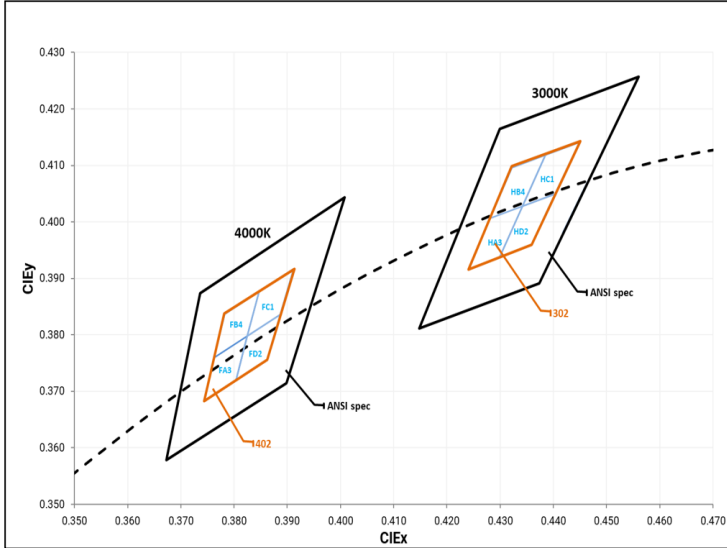

Chromaticity Bin Kit Codes

CCT	Bin Kit	Chromaticity Bins
3000K	302	HA3, HB4, HC1, HD2
4000K	402	FA3, FB4, FC1, FD2
5000K	502	DA, DB, DC, DD
5700K	572	CA, CB, CC, CD
6500K	652	BA, BB, BC, BD

Note:

- LED chromaticity is measured and binned at 25°C ambient temperature with 700 mA 20 ms single pulse.
- Luminus maintains a tolerance of ± 0.005 on Chromaticity (CIE_x, CIE_y) measurement.



Absolute Maximum Ratings

		Symbol	Values	Unit
DC Forward Current	Minimum	$I_{f\ min}$	0.1	A
	Maximum	$I_{f\ max}$	2.0	
Surge Current (t<10 ms, Duty Cycle < 10%)		I_s	3.0	A
Reverse Voltage (@ $I_f = 10\ mA$)		V_r	5	V
Power Dissipation		P_D	7	W
Junction Temperature		$T_{j\ max}$	150	°C
Operating Temperature		T_{opr}	-40 to 100	°C
Storage Temperature		T_{stg}	-40 to 100	°C
ESD withstand Voltage HBM Per ANSI/ESDA/JEDEC JS-001		V_{HBM}	8	kV
ESD withstand Voltage CDM Per ANSI/ESDA/JEDEC JS-002		V_{CDM}	1	kV

Product Characteristics

Parameter		Symbol	Value	Unit
Color Rendering Index ¹ ($T_j = 85^\circ\text{C}$)		CRI	> 80	
Viewing Angle (FWHM)		$2\theta_{1/2}$	120	°
Forward Voltage ($I_f = 700\ mA$, $T_j = 85^\circ\text{C}$)	Minimum	$V_{f\ min}$	2.5	V
	Typical	$V_{f\ typ}$	2.8	
	Maximum	$V_{f\ max}$	3.1	
Temperature Coefficient of Voltage		$\partial_{V_f}/\partial_T$	-1.13	mV/°C
Thermal Resistance (Electrical) Junction/Solder Point		$R_{thjs-EL}$	1.6	°C/W

Note:

1. Luminus maintains a tolerance of ± 2 on Color Rendering Index (CRI) measurement.



Relative Luminous Flux

Forward Current: $\phi_v/\phi_v(0.7\text{ A}), T_j = 85^\circ\text{C}$

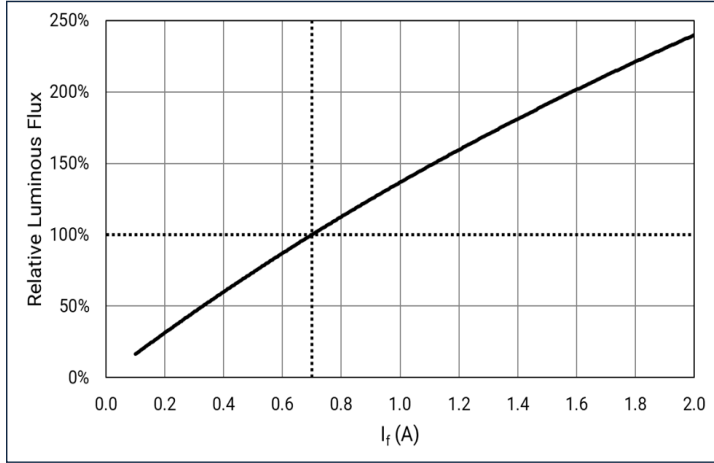

Temperature (T_j): $\phi_v/\phi_v(85^\circ\text{C}), I_f = 0.7\text{ A}$

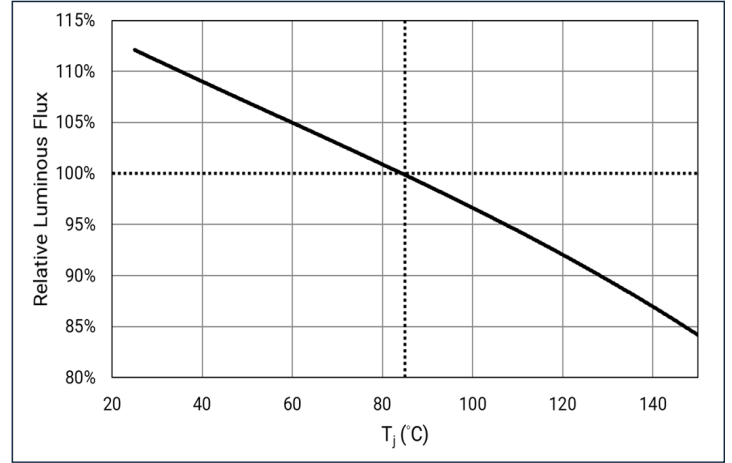

Forward Voltage

Forward Current: $\Delta V_f = V_f(I_f) - V_f(0.7\text{ A}), T_j = 85^\circ\text{C}$

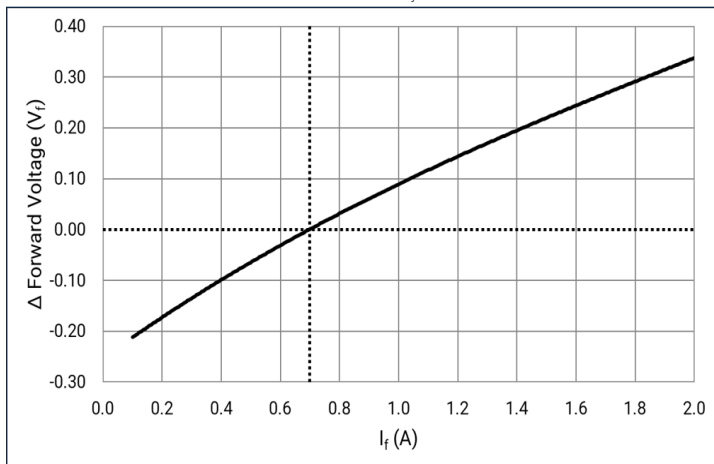

Temperature (T_j): $\Delta V_f = V_f(T_j) - V_f(85^\circ\text{C}), I_f = 0.7\text{ A}$

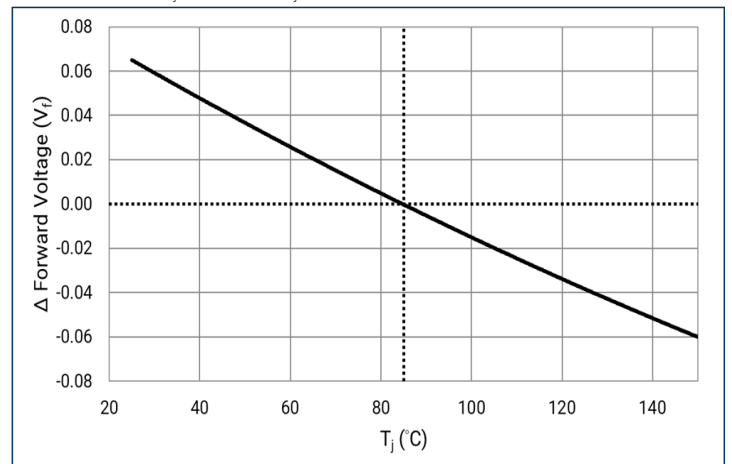



Relative Chromaticity - Warm White (3000K, 4000K)

Forward Current: $\Delta CIE_{x,y} = CIE_{x,y}(I_f) - CIE_{x,y}(0.7 A)$, $T_j = 85^\circ C$

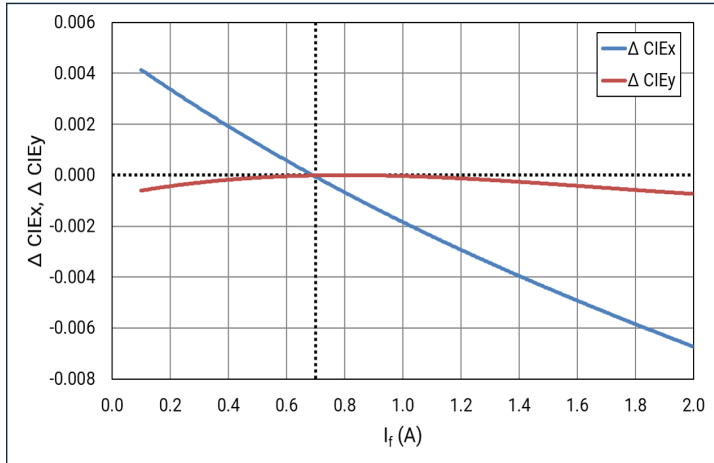

Temperature (T_j): $\Delta CIE_{x,y} = CIE_{x,y}(T_j) - CIE_{x,y}(25^\circ C)$, $I_f = 0.7 A$

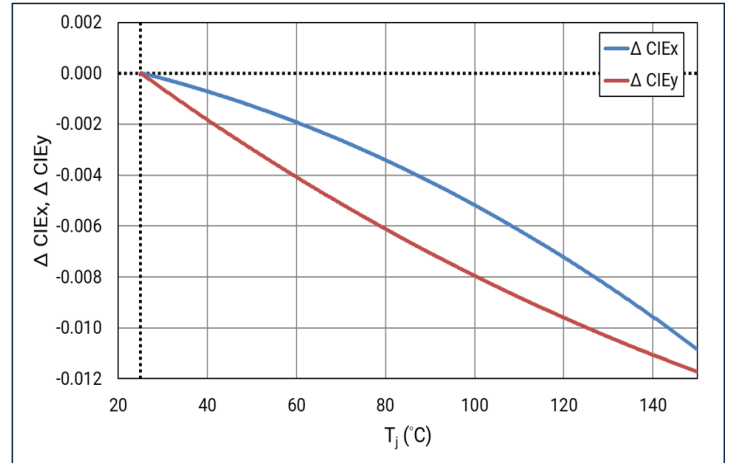

Relative Chromaticity - Cool White (5000K, 5700K, 6500K)

Forward Current: $\Delta CIE_{x,y} = CIE_{x,y}(I_f) - CIE_{x,y}(0.7 A)$, $T_j = 85^\circ C$

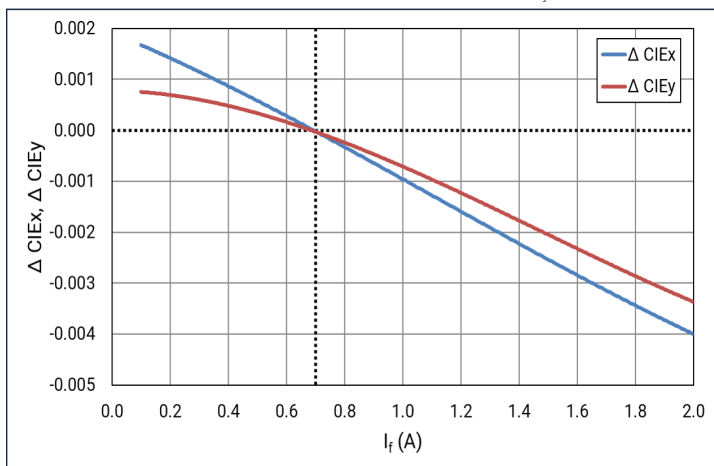

Temperature (T_j): $\Delta CIE_{x,y} = CIE_{x,y}(T_j) - CIE_{x,y}(25^\circ C)$, $I_f = 0.7 A$

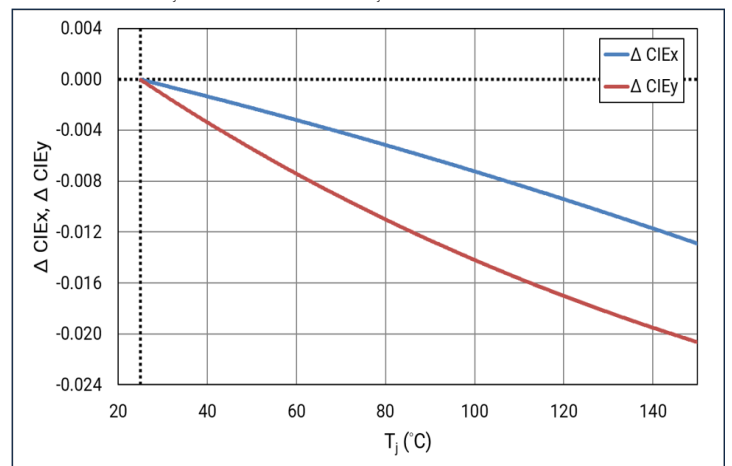



Angular Distribution

$I_f = 0.7 \text{ A}; T_j = 25^\circ\text{C}$

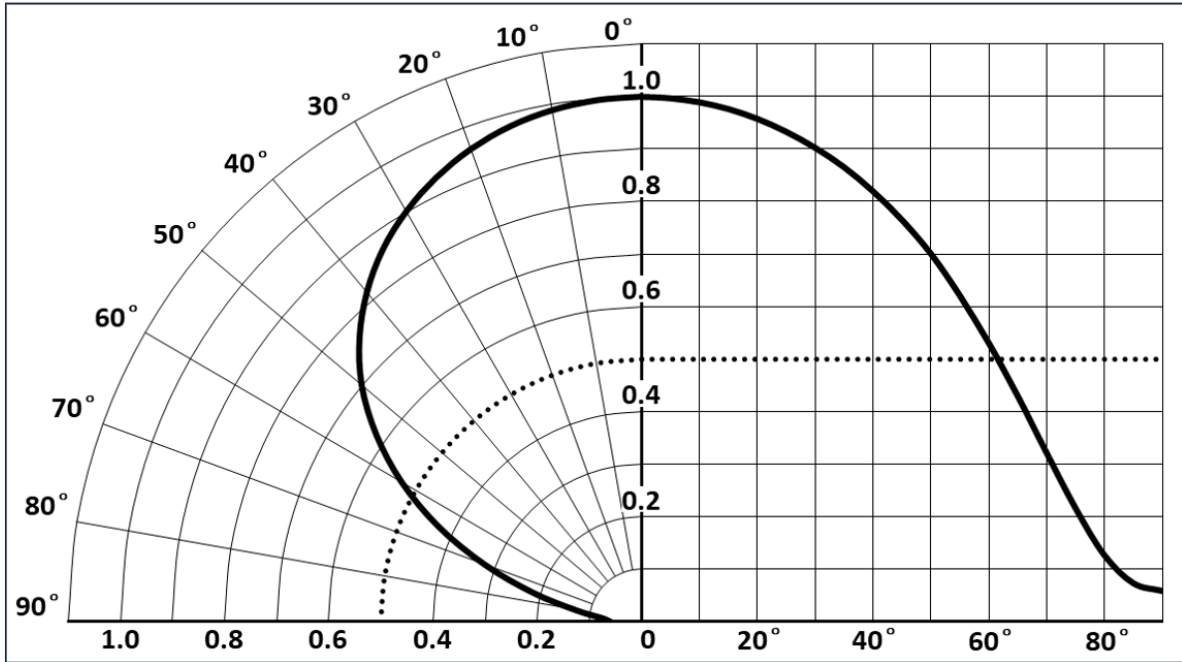

Relative Spectral Power Distribution

$I_f = 0.7 \text{ A}; T_j = 85^\circ\text{C}$

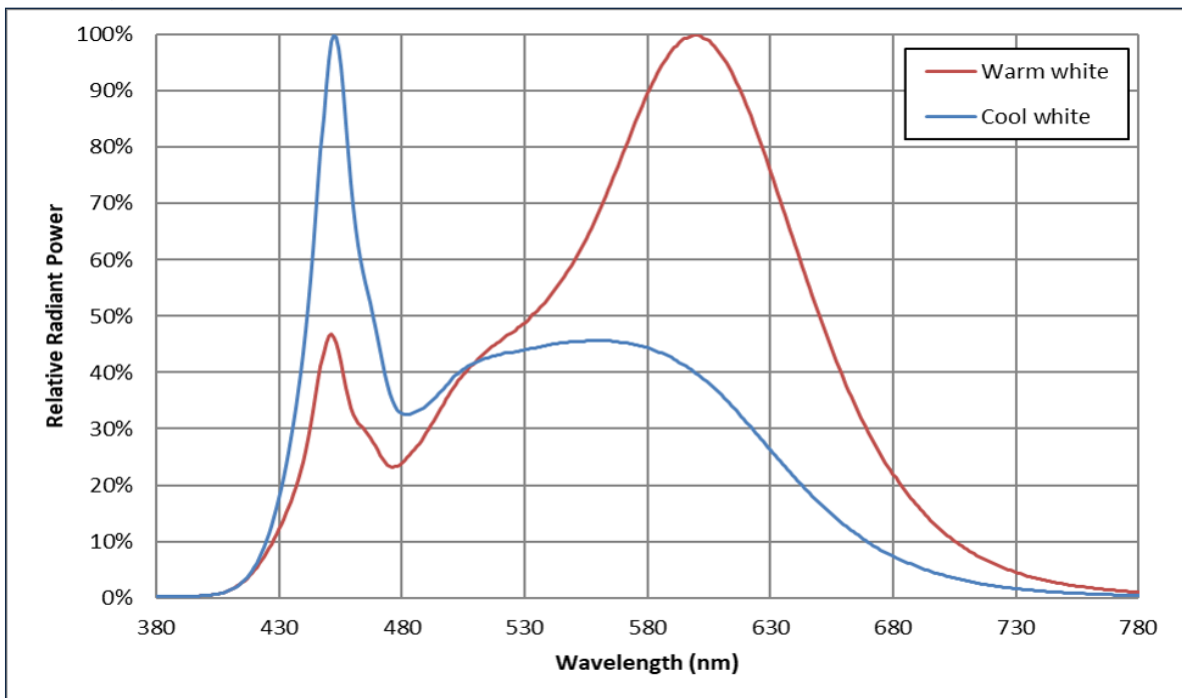



Soldering Profile

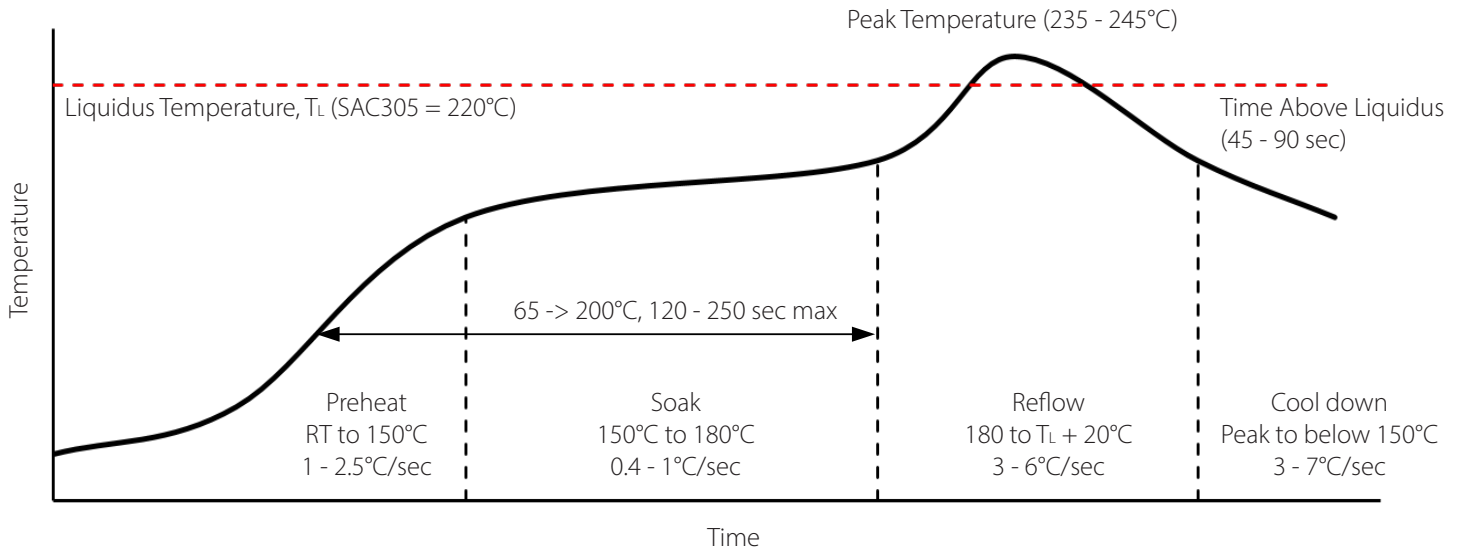

SMT Rework Guideline	Manual Hotplate Reflow	Hot Air Gun Reflow
Heating Time		< 60 sec
Hotplate Temperature	< 245°C	< 150°C

Note:

- Product complies to Moisture Sensitivity Level 3 (MSL 3).
- The numbers in the table are specific to SAC305. Luminus recommends using an SAC305 solder paste with a no-clean flux for RoHS compliant products.
- During the pick and place process, axial forces on the dome (or window) should not exceed 0.5 Newtons (N).
- Use of a multi-zone IR reflow oven with a nitrogen blanket is recommended.
- Time-temperature profile of the reflow process showing the four functional profile zones are defined in IPC-7801. Temperature is referenced to the center of the PCB.
- Luminus recommends to use the solder paste data sheet information as a starting point in time-temperature process development.
- These are general guidelines. Consult the solder paste manufacturer's datasheet for guidelines specific to the alloy and flux combination used in your application. For more information, please refer to:
<https://luminusdevices.zendesk.com/hc/en-us/articles/360060306692-How-do-I-Reflow-Solder-Luminus-SMD-Components->
- For any technical questions about soldering process, please contact Luminus at techsupport@luminus.com.



Mechanical Dimensions - Type A Solder Pad¹

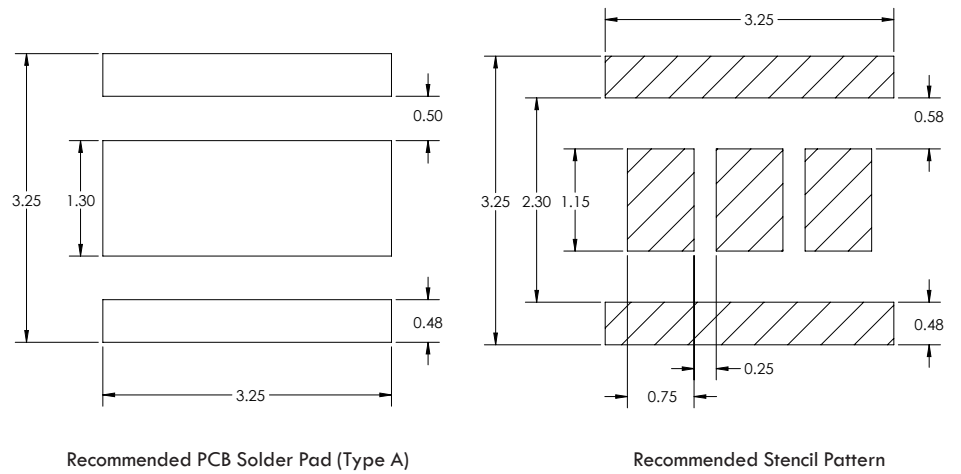
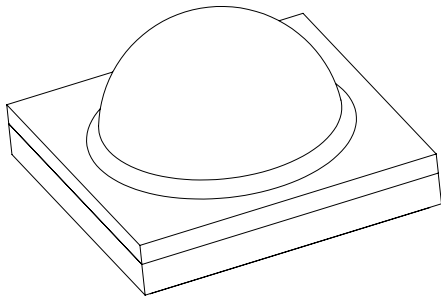
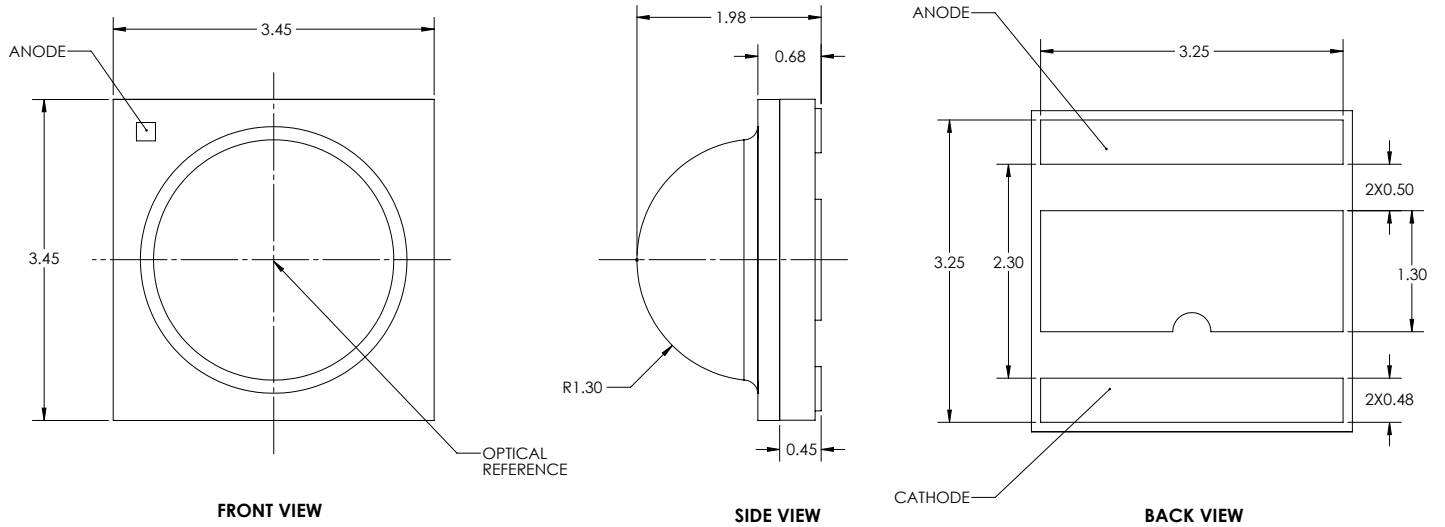

Note:

1. All dimensions are in millimeter ± 0.13 mm.



Mechanical Dimensions - Type B Solder Pad¹

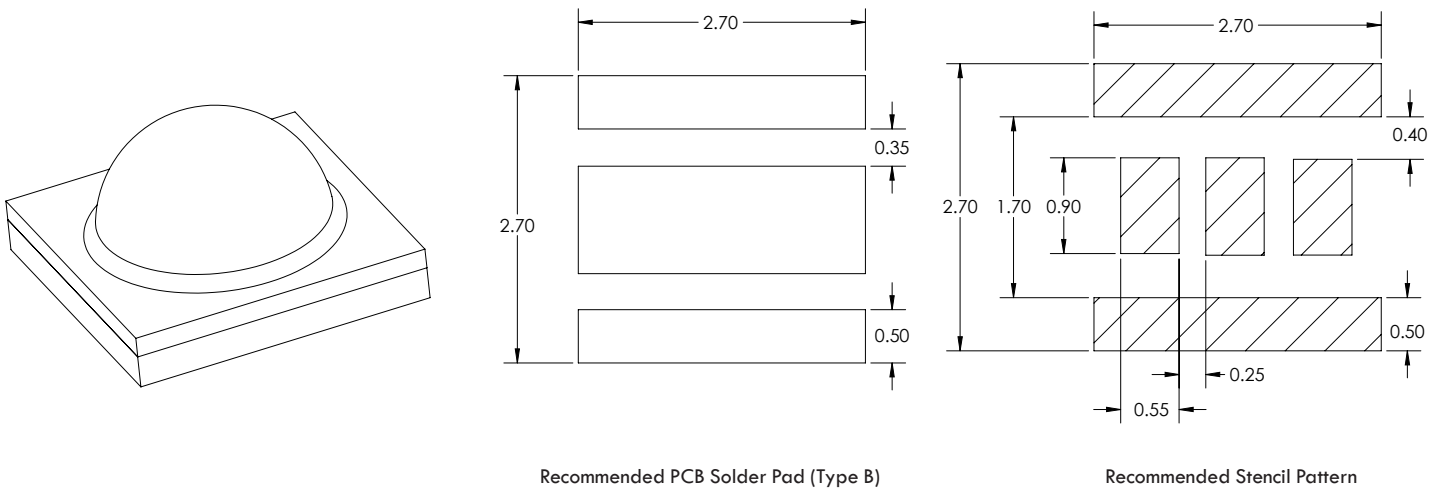
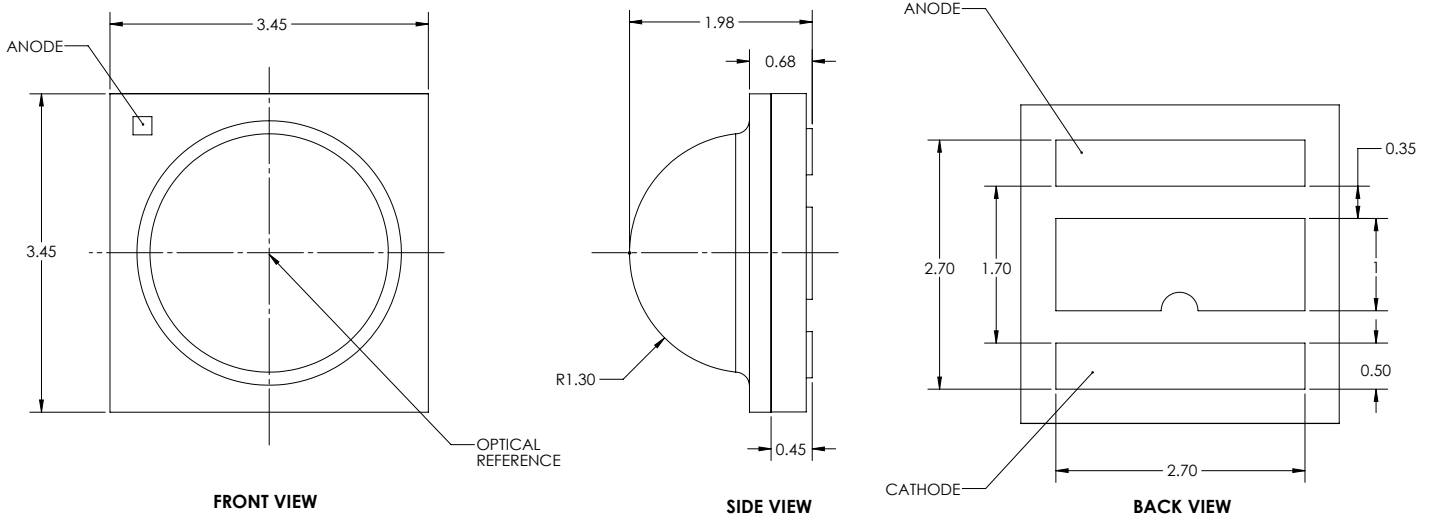

Note:

1. All dimensions are in millimeter ± 0.13 mm.



Tape and Reel Outline

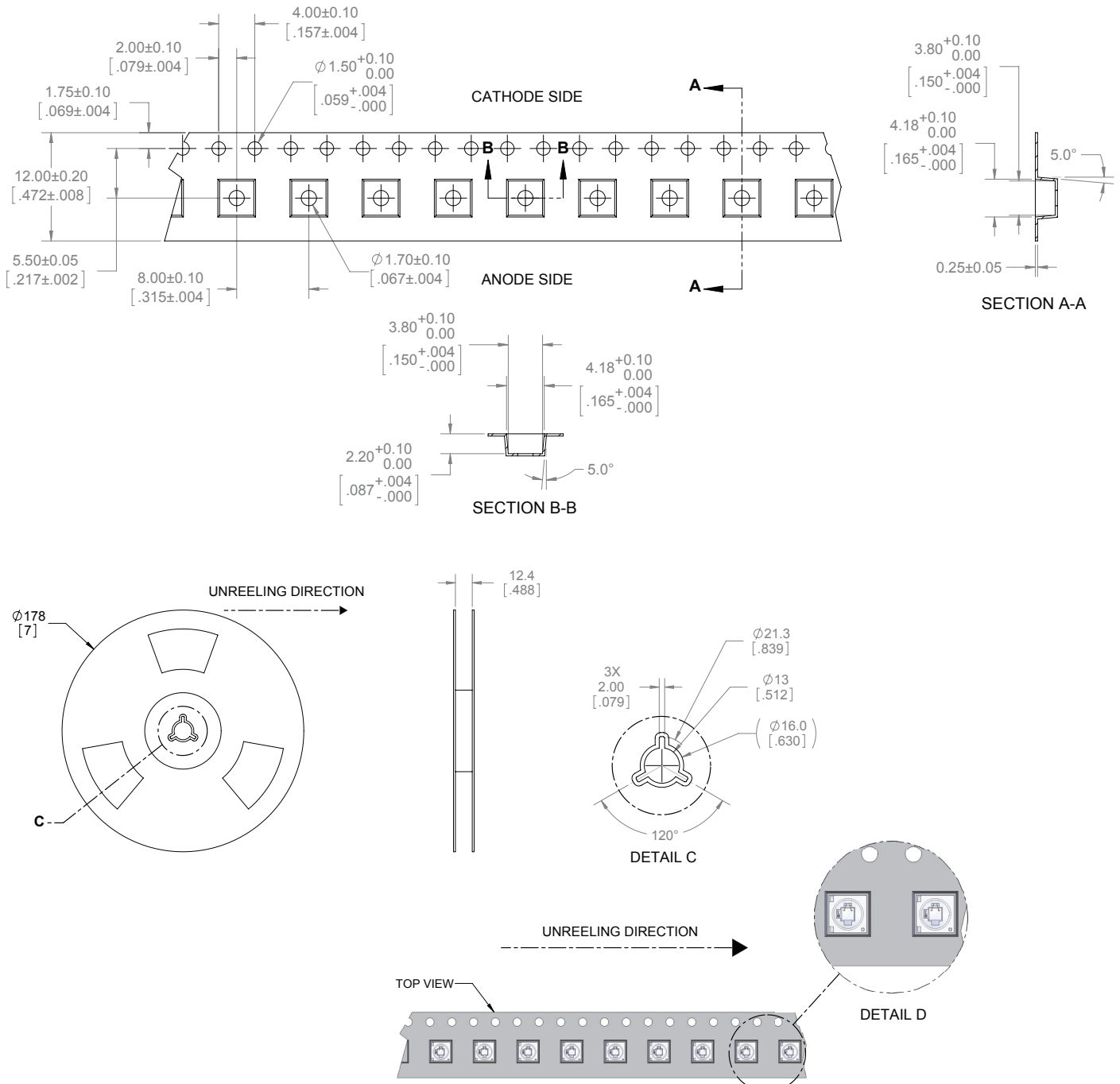

Note:

1. Each reel contains 1,000 units.
2. Leave 160 mm of type empty for lead in (20 empty pockets).
3. Leave 480 mm of type empty for trailer (60 empty pockets).
4. Must comply to EIA-481-C-2003.
5. Final tape and reel packaging must meet the requirements of JEDEC-STD-033, LEVEL 2A.



Shipping Label

Label on Packaging Box

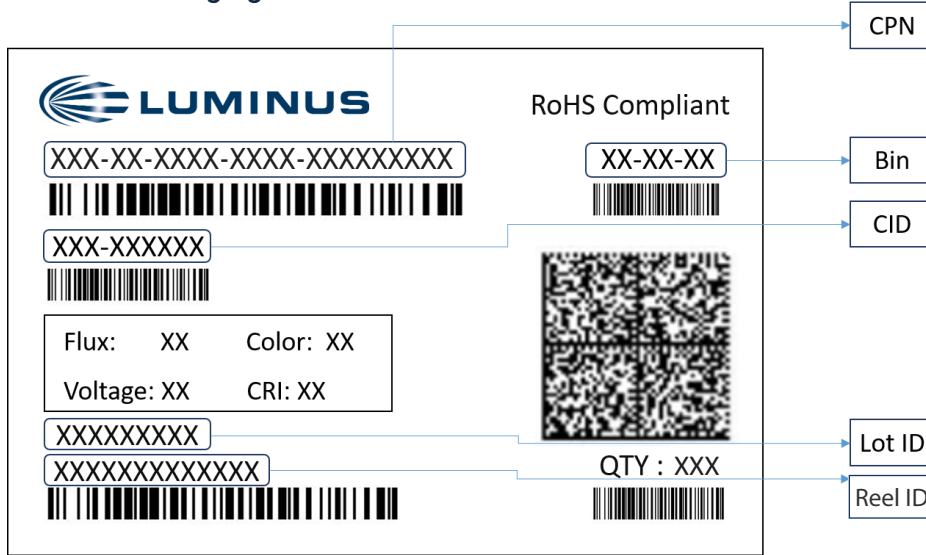

Label Fields:

- CPN: Luminus ordering part number
- CID: Customer's part number
- QTY: Quantity of parts per reel
- Flux: Bin as defined on page 4
- Voltage: Bin as defined on page 4
- Color: Bin as defined on page 5
- CRI: NA
- Lot ID & Reel ID: For Luminus internal use

Label on Reel

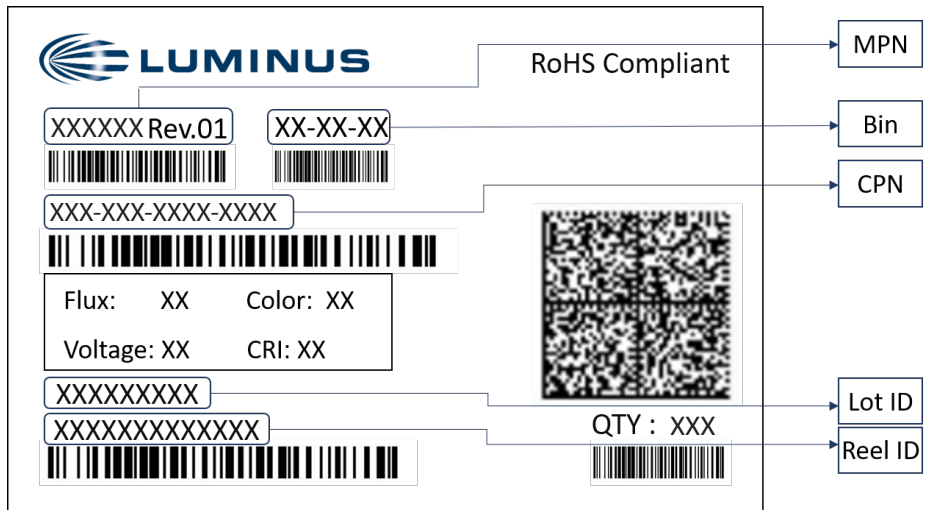

Label Fields:

- CPN: Luminus ordering part number
- MPN: For Luminus internal use
- QTY: Quantity of parts per reel
- Flux: Bin as defined on page 4
- Voltage: Bin as defined on page 4
- Color: Bin as defined on page 5
- CRI: NA
- Lot ID & Reel ID: For Luminus internal use



Packaging

Packaged Reel

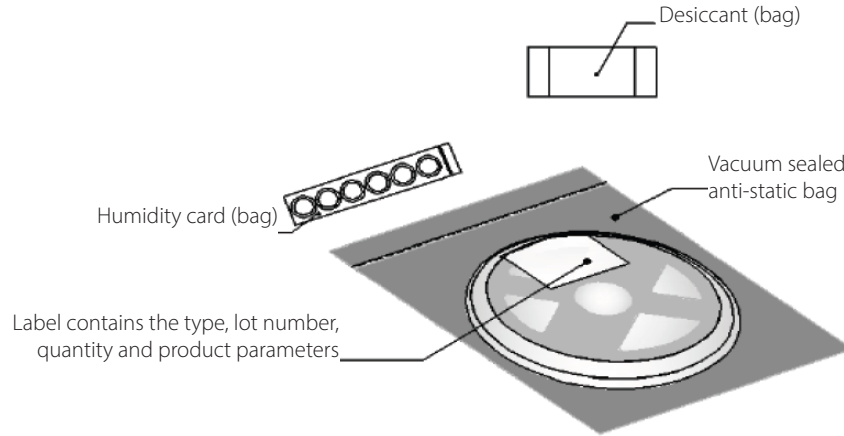

Packaging boxes

Box Size 1 - 5 reels per box
Size: 22.5 x 24.5 x 6.5 cm

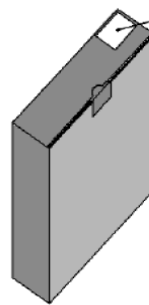
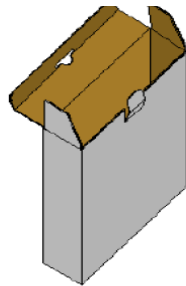

Label contains the type, lot number, quantity and product parameters

*Capacity 5 reels per box

Box Size 2 - 10 reels per box
Size: 22.5 x 24.5 x 13 cm

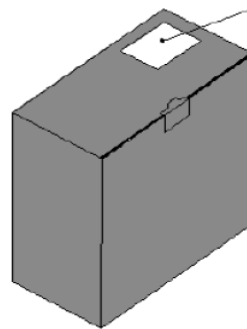
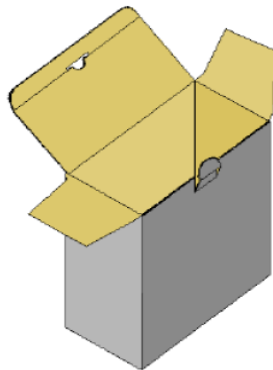

Label contains the type, lot number, quantity and product parameters

*Capacity 10 reels per box

Packing Configuration:

- 1,000 units per reel
- Each reel is enclosed in anti-static bag
- Shipping label is placed on top of each reel
- Multiple labels are attached to the box (one label per reel inside the box)



Notes

Static Electricity

1. The products are sensitive to static electricity, and care should be taken when handling them.
2. Static electricity or surge voltage will damage the LEDs. It is recommended to wear anti-electrostatic gloves or wristband when handling the LEDs.
3. All devices, equipment and machinery must be properly grounded. It is recommended that measures be taken against surge voltage to the equipment that mounts the LEDs.

Reference: [APN-002815](#) Electrical Stress Damage to LEDs and How to Prevent It

Storage

1. Before opening the package

The LEDs should be kept at a temperature lower than 40°C and relative humidity lower than 90%. The LEDs should be used within a year. When storing the LEDs, moisture proof package with absorbent material (silica gel) is recommended.

2. After opening the package

The LEDs should be kept at a temperature lower than 30°C and relative humidity lower than 60%. The LEDs should be soldered within 168 hours (7 days) after opening the moisture proof package.

If unused LEDs remain, they should be stored in moisture proof packages, such as sealed containers with moisture absorbent material (silica gel). It is also recommended to return the unused LEDs to the original moisture proof package and to seal it again.

If the moisture absorbent material (silica gel) vaporizes or passes the expiration date, baking treatment should be performed by using the following conditions : 60°C for 20 hours.

The LED's electrode and lead frame comprise a silver plated copper alloy. The silver surface may be affected by environments. Please avoid conditions which may cause the LEDs to corrode or discolor. The corrosion or discoloration might lower solderability or affect optical characteristics.

Please avoid rapid transition in ambient temperature, especially in high humidity environments where condensation can occur.