

XBT-3535-285 nm

Surface Mount UVC LED

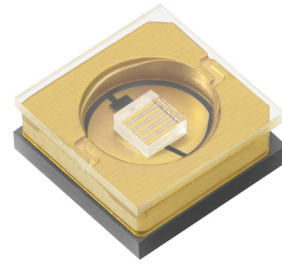

Features

- UV LED with peak wavelength 280 - 290 nm
- High Optical Power: Up to 135 mW of UVC power at maximum rated current
- Compact form factor: 3.5 mm x 3.5 mm package with optically transparent window
- Viewing angle of 130 degrees
- Standard SMT process



Applications

- Horticulture
- Analytical Instruments
- Healthcare
- Water/ Air/ Surface Disinfection
- Food & Pharmaceutical Processing

Table of Contents

Ordering Information.	2
Binning Structure.	3
Absolute Maximum Ratings	4
Device Performance	5
Angular distribution and Typical Spectrum.	7
Soldering Profile	8
Mechanical Dimensions	9
Shipping Reel Outline	10
Shipping Label	11
Notes	12
Revision History	13



Ordering Information

Ordering Part Numbers¹

Wavelength Range (nm)	Wavelength Bins	Radiometric Flux		Ordering Part Number
		Bin Kit Flux Code	Min. Flux (mW)	
280 - 290	280 , 285	DB	70	XBT-3535-UV-A130H-DB280-00

Part Number Nomenclature

XBT	3535	UV	A130H	<FFWWW-#>
Product Family	Package Size	Color	Package Configuration	Bin Kit
XBT: UVC Surface Mount Package	3535: 3.5 mm x 3.5 mm	UV: Ultraviolet	A130H: 130 deg viewing angle	Flux and Wavelength bin kit code - See ordering information

Note:

1. Flux Bin listed is minimum bin shipped, higher bins may be included at Luminus' discretion.



Binning Structure

XBT-3535-UV LEDs are tested at a drive current of 500 mA, 20 ms single pulse at 25°C and placed into one of the following radiometric flux and wavelength bins.

Radiometric Flux Bins^{1,2}

Color	Flux Bin ³	Binning @ 500 mA, T _c = 25°C ^{4,5}		Correlated Minimum Flux (mW) @ T _c = 25°C		
		Min. Flux (mW)	Max. Flux (mW)	350 mA	650 mA	800 mA
UV	DB	70	80	52	87	103
	DC	80	90	59	100	118
	DD	90	100	66	112	133
	DE	100	120	74	125	148
	FA	120	140	88	149	177

Wavelength Bins²

Color	Wavelength Bin ^{3,6}	Binning @ 500 mA, T _c = 25°C ^{4,5}	
		Minimum Wavelength (nm)	Maximum Wavelength (nm)
UV	280 , 285	280	290

Note:

1. Luminus maintains a +/- 6% tolerance on flux measurements and a +/- 0.5 nm tolerance on peak wavelength measurements.
2. Products are production tested then sorted and packed by bin.
3. Individual bins are not orderable. Please refer to the Product Ordering information page for a list of orderable bin kits.
4. Product test condition: 500 mA, 20 ms pulse at 25 °C.
5. T_c = Case temperature.
6. The wavelength bin as marked on the product label may be followed by a letter which is for internal use only.



Absolute Maximum Ratings¹

Parameter	Symbol	Value	Unit
Forward Current	$I_{f \max}$	800	mA
Storage Temperature	$T_{s \min}$	-40	°C
	$T_{s \max}$	100	
Junction Temperature	$T_{j \max}$	100	°C
ESD sensitivity ANSI/ESDA/JEDEC JS-001 (HBM, Class 3B)	V_{ESD}	8000	V

Note:

1. XBT-3535-UV LEDs are designed for operation up to an absolute maximum forward drive current as specified above. Product lifetime data is specified at typical forward drive currents. Sustained operation at absolute maximum currents will result in a reduction of device lifetime compared to typical forward drive currents. Actual device lifetimes will also depend on junction temperature.



Device Performance^{1,2}

Optical and Electrical Characteristics	Symbol	Value	Unit
Test Current	I_f	500	mA
Forward Voltage	$V_{f\min}$	5.0	V
	$V_{f\text{typ}}$	6.2	
	$V_{f\max}$	7.5	
FWHM	$\Delta\lambda$	13	nm
Viewing Angle	$2\theta_{1/2}$	130	°
Thermal Characteristics			
Thermal Resistance (junction-solder point) ³	$R_{th\text{elec}}$	5.4	°C/W

Note:

1. Ratings are based on operation at a constant temperature of $T_c = 25^\circ\text{C}$. Test conditions: 500 mA, 20 ms pulse at 25°C .
2. XBT-3535-UV LEDs are short wavelength, deep UV LEDs. During operation, the LED emits high intensity UVC radiation, which is harmful to skin and eyes. UV light is also hazardous to skin and may cause cancer. Avoid exposure to deep UV light when LED is operational.
3. Measurements are in accordance with JEDEC 51-14. For more about thermal resistance calculation, please see <https://luminusdevices.zendesk.com/hc/en-us/articles/4416807960717-Thermal-Heatsink-Required-Rth-Calculator>



Relative Radiometric Flux

Forward current: $\phi_v/\phi_v(500\text{ mA})$, 20 ms pulse, $T_c = 25^\circ\text{C}$

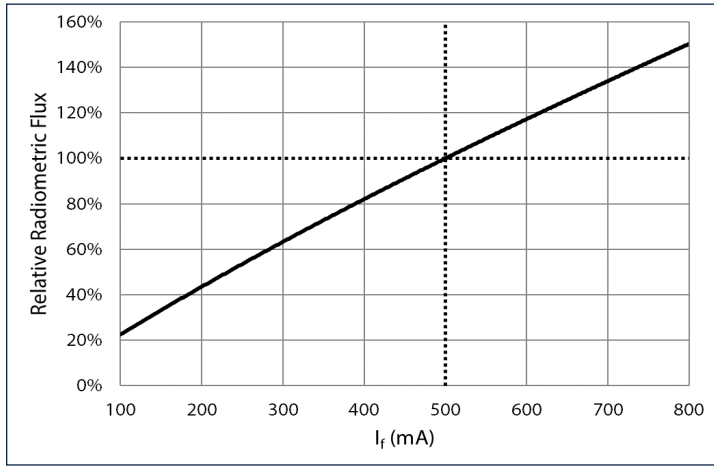

Temperature: $\phi_v/\phi_v(25^\circ\text{C})$, 20 ms pulse, $I_f = 500\text{ mA}$

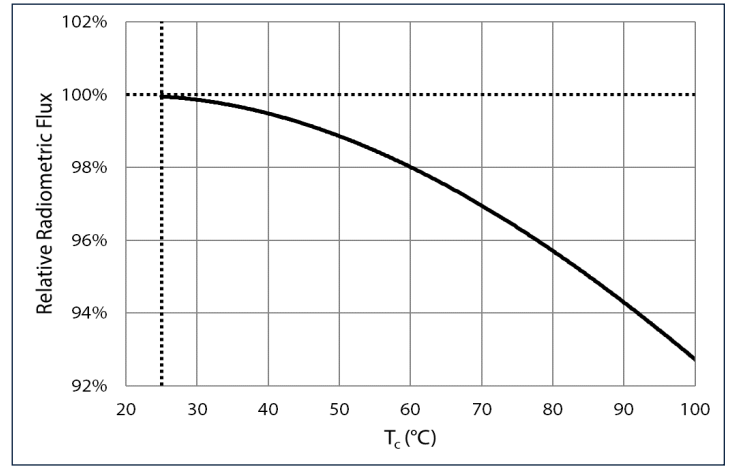

Forward Voltage Shift

Forward current: $\Delta V_f = V(I_f) - V(500\text{ mA})$, 20 ms pulse, $T_c = 25^\circ\text{C}$

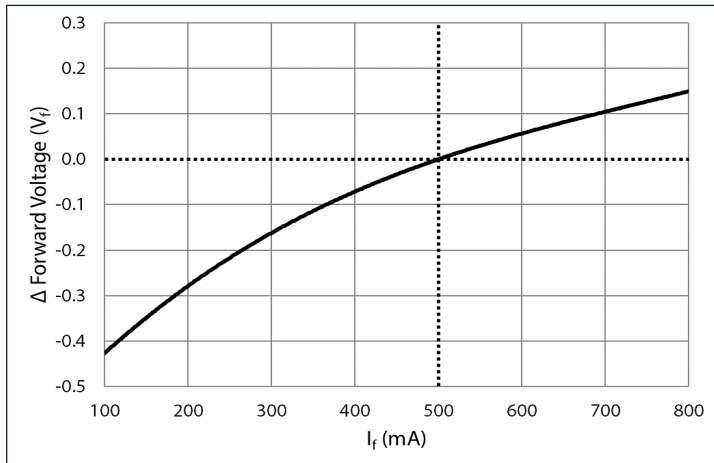

Temperature: $\Delta V_f = V(T_c) - V(25^\circ\text{C})$, 20 ms pulse, $I_f = 500\text{ mA}$

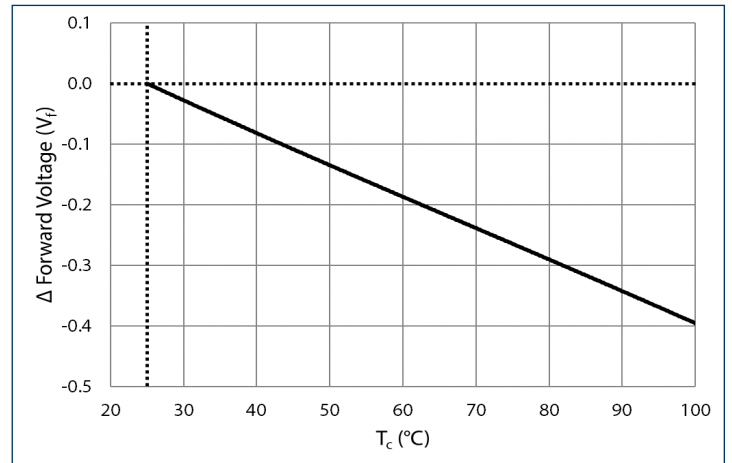

Peak Wavelength Shift

Forward current: $\Delta \lambda_d = \lambda_d(I_f) - \lambda_d(500\text{ mA})$, 20 ms pulse, $T_c = 25^\circ\text{C}$

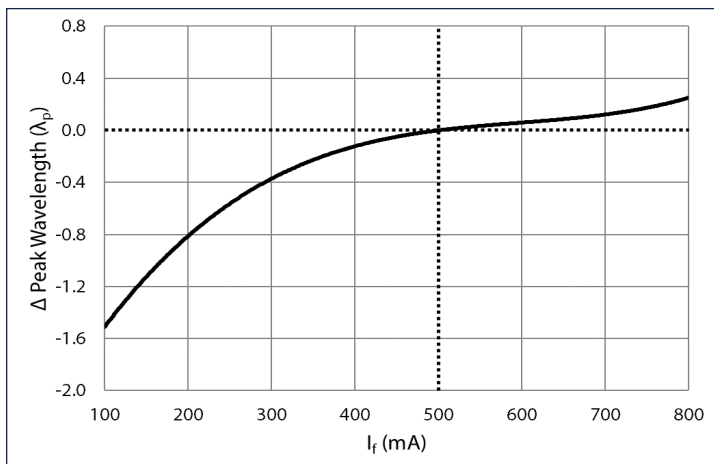

Temperature: $\Delta \lambda_d = \lambda_d(T_c) - \lambda_d(25^\circ\text{C})$, 20 ms pulse, $I_f = 500\text{ mA}$

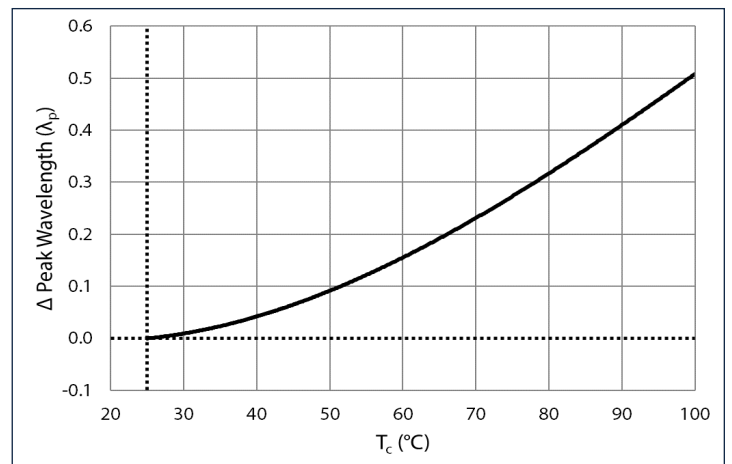



Angular distribution and Typical Spectrum

Angular distribution

$$I_{\text{ref}} = f(\Phi); T_c = 25^\circ\text{C}$$

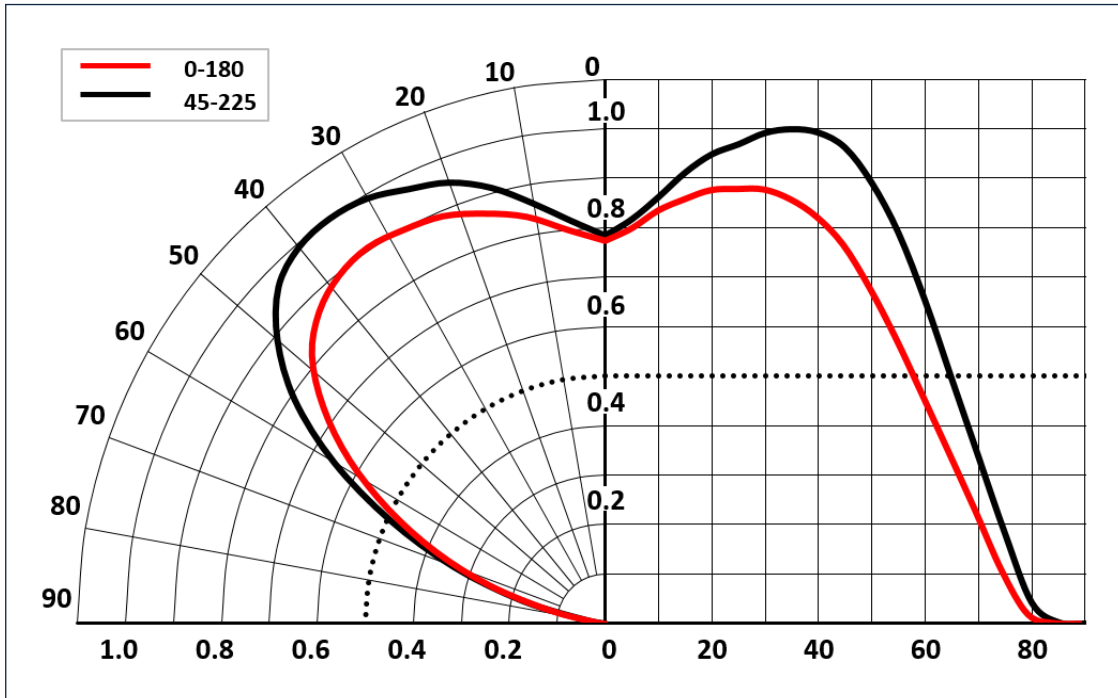

Typical Spectrum

$$\Phi_{\text{ref}} = f(\lambda); I_f = 500\text{mA}; T_c = 25^\circ\text{C}$$

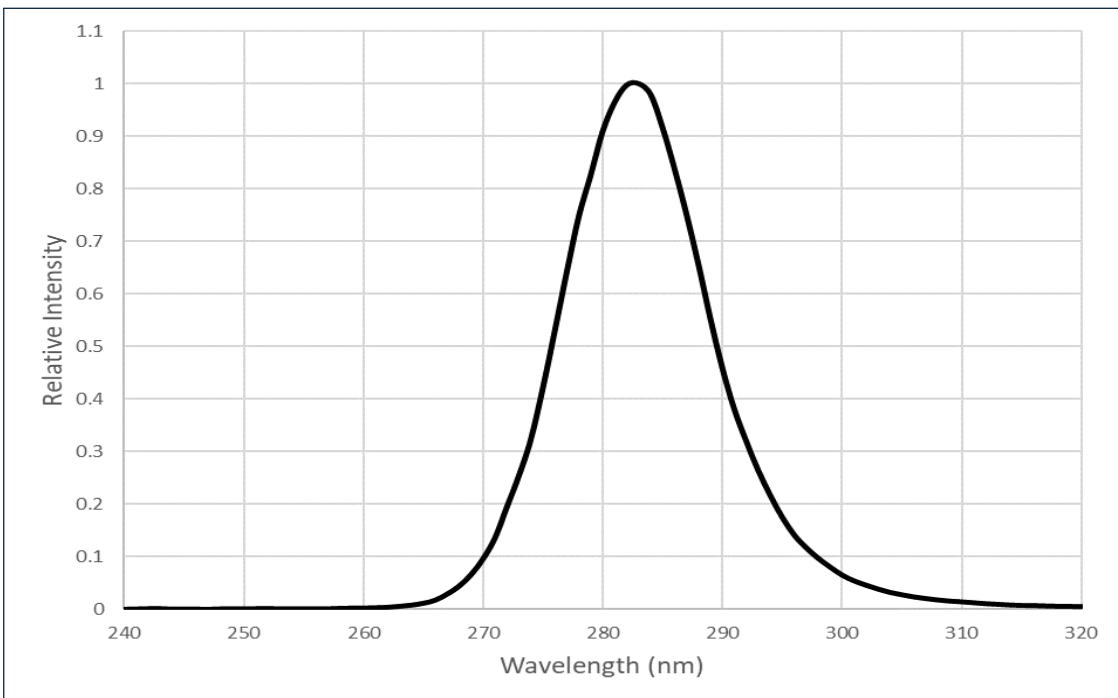



Soldering Profile

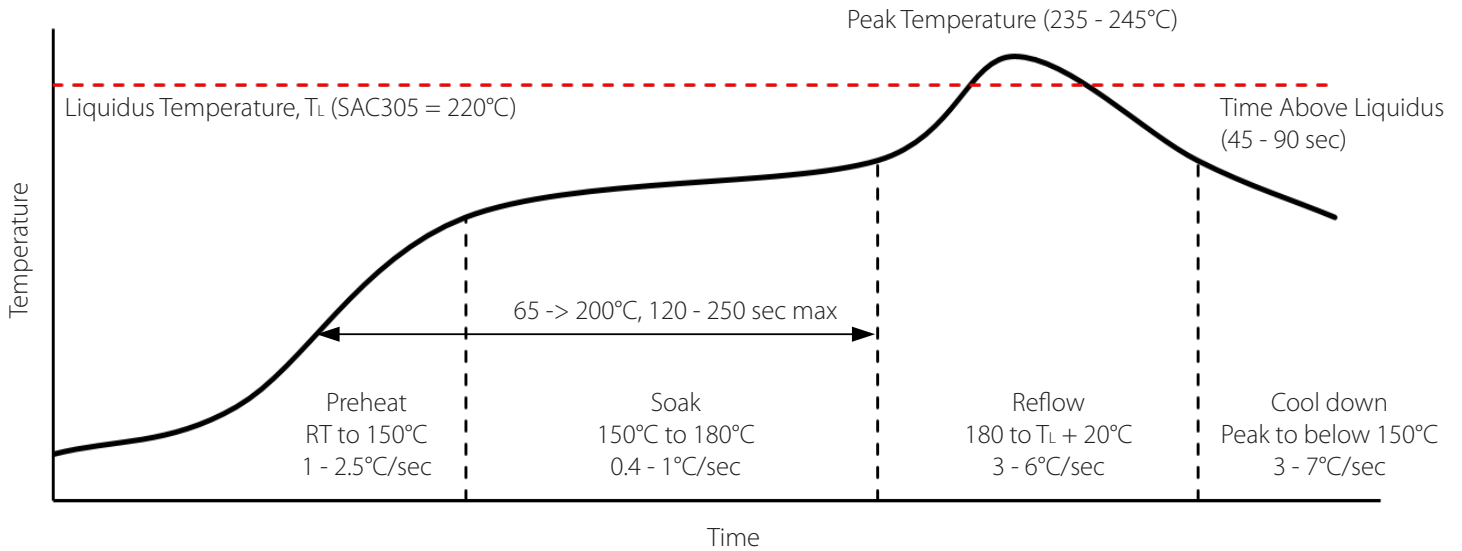

SMT Rework Guideline	Manual Hotplate Reflow	Hot Air Gun Reflow
Heating Time	< 60 sec	
Hotplate Temperature	< 245°C	< 150°C

Note:

- Product complies to Moisture Sensitivity Level 1 (MSL 1).
- The numbers in the table are specific to SAC305. Luminus recommends using an SAC305 solder paste with a no-clean flux for RoHS compliant products.
- During the pick and place process, axial forces on the dome (or window) should not exceed 0.5 Newtons (N).
- Use of a multi-zone IR reflow oven with a nitrogen blanket is recommended.
- Time-temperature profile of the reflow process showing the four functional profile zones are defined in IPC-7801. Temperature is referenced to the center of the PCB.
- Luminus recommends to use the solder paste data sheet information as a starting point in time-temperature process development.
- These are general guidelines. Consult the solder paste manufacturer's datasheet for guidelines specific to the alloy and flux combination used in your application.
For more information, please refer to:
<https://luminusdevices.zendesk.com/hc/en-us/articles/360060306692-How-do-I-Reflow-Solder-Luminus-SMD-Components->
- For any technical questions about soldering process, please contact Luminus at techsupport@luminus.com.



Mechanical Dimensions

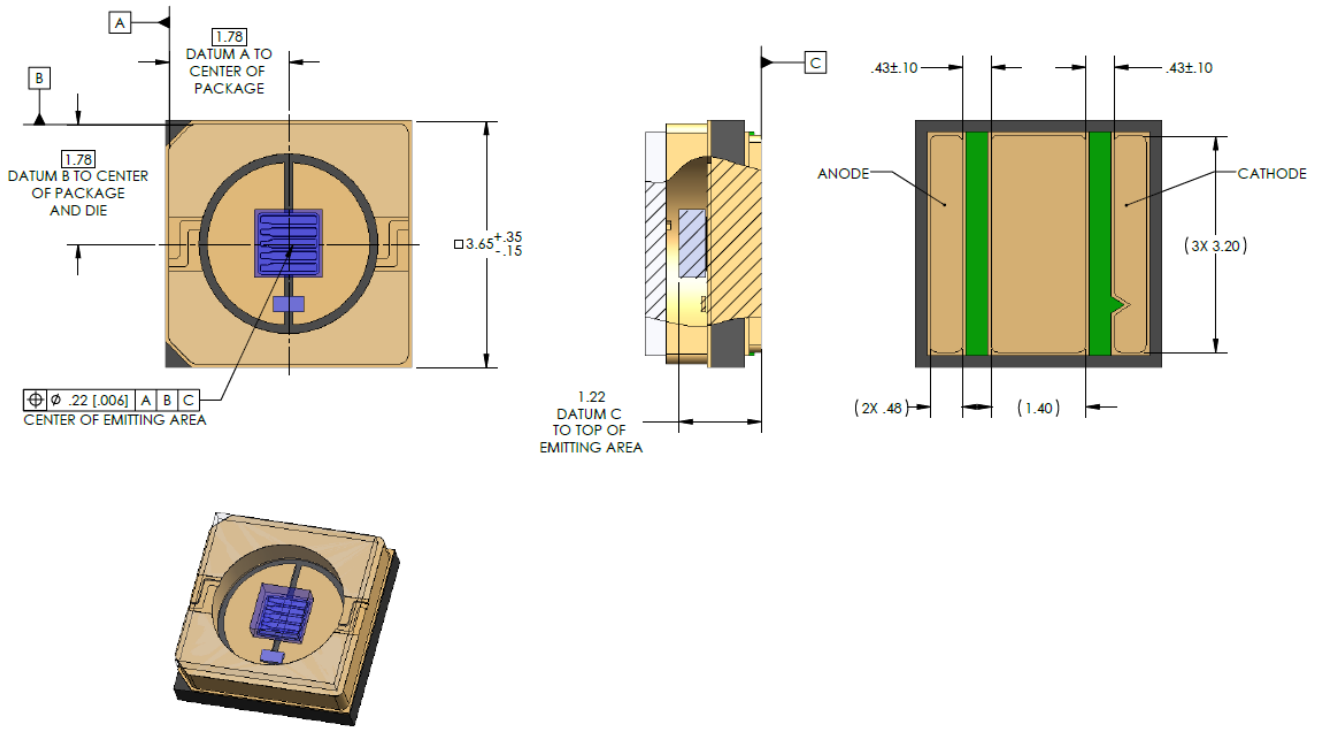

Recommended Solder Pad

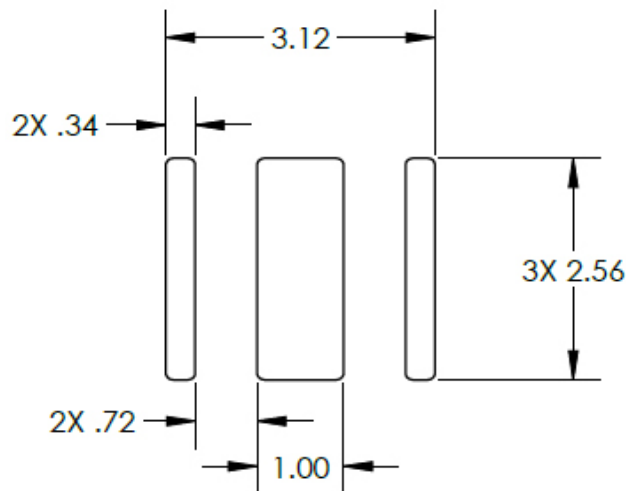



Shipping Reel Outline

All XBT-3535 products are packaged and labeled with their respective bin as outlined in the tables on page 3.

Each reel will only contain one flux and one wavelength bin.

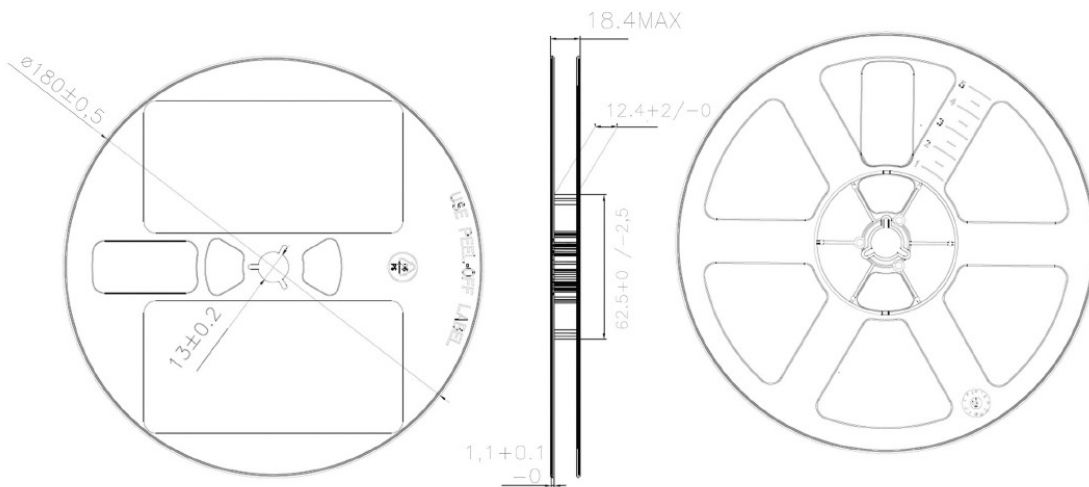
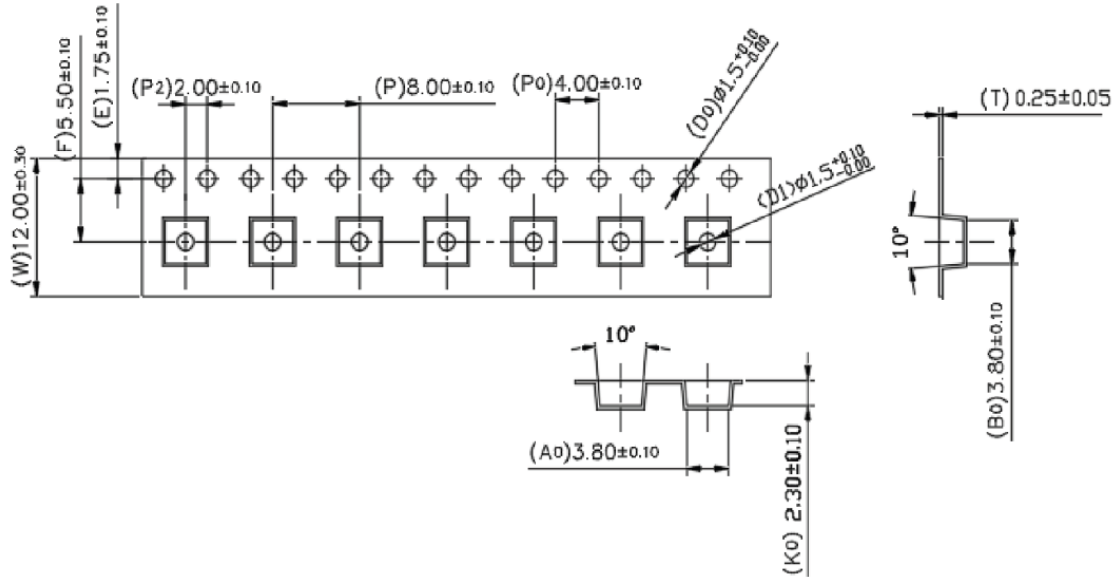



Shipping Label

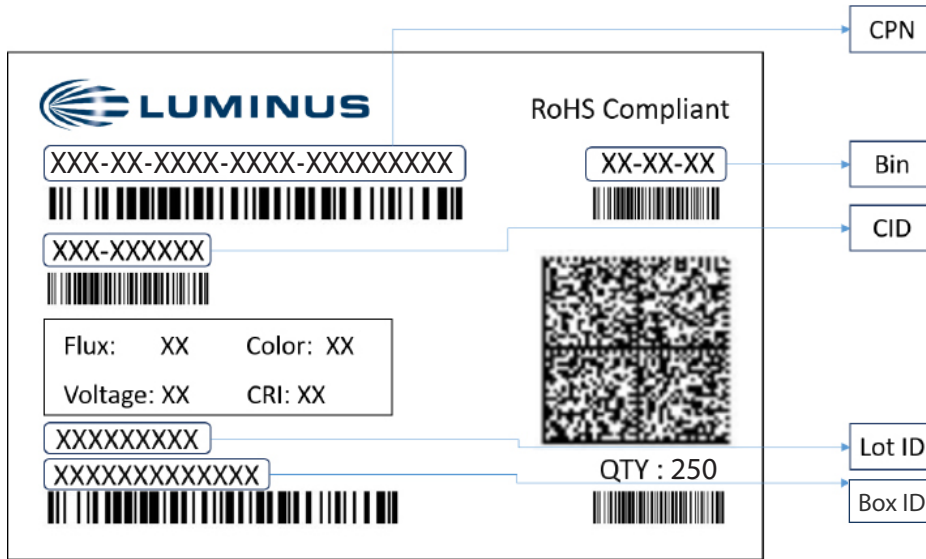

Label Fields:

- CPN: Luminus ordering part number
- CID: Customer's part number
- QTY: Quantity of devices in pack
- Flux: Bin as defined on page 3
- Wavelength: Bin as defined in page 3
- Voltage: NA
- Color: Bin as defined on page 3
- CRI: NA

Packing Configuration:

- Maximum of 250 devices per reel, minimum of 50 devices per reel
- Partial pack or reel may be shipped
- Each pack is enclosed in anti-static bag
- Shipping label is placed on top of each pack



Notes

Static Electricity

This product is sensitive to static electricity, and care should be taken when handling them. Static electricity or surge voltage will damage the LEDs. It is recommended to wear an anti-electrostatic wristband or anti-electrostatic gloves when handling the LEDs. All devices, equipment and machinery must be properly grounded. It is recommended that measures be taken to isolate LED processing equipment from potential sources of voltage surges.

Reference: APN-002815 Electrical Stress Damage to LEDs and How to Prevent It

Eye Safety

According to the test specification risk group IEC 62471: 2008-Non-GLS under 500 mA, this product complies to Risk group 3 (RG3) High risk, exceed the limits for Risk Group 2.

Warning: This product emits invisible light - there is no aversion response.

Avoid eye and skin exposure to un-shielded product.

For more information, please refer to: <https://luminusdevices.zendesk.com/hc/en-us/articles/10532958752397>



Revision History

Rev	Date	Description of Change
01	06/02/2023	Rev 01 - Initial release
02	11/10/2023	Updated ordering part number
03	03/06/2024	Updated flux bins