

# XFM-5050-UV

## 2-chip Surface Mount

### UVC LED

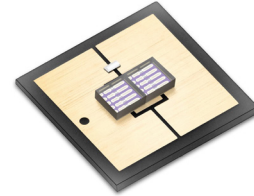

### Table of Contents

Binning Structure . . . . .	2
Ordering Information . . . . .	3
Optical and Electrical Characteristics . . . . .	4
Mechanical Dimensions . . . . .	7
Soldering Profile . . . . .	8
Packing & Labeling . . . . .	9
Precautions for Use . . . . .	10
History of Changes . . . . .	11

### Features

---

- Ultra-high power UVC LED: >120 mW output power at 275 nm
- Compact, cost effective 5050 package
- Designed to maximize irradiance in high flow applications
- Wide viewing angle of 130°
- Standard SMT Process
- RoHS and REACH compliant

### Applications

---

- Air Purification
- Water Purification
- Surface Disinfection
- Medical Device Sterilization
- Appliance Sterilization
- Food & Beverage Preparation

## XFM-5050-UV Binning Structure

XFM-5050-UV LEDs are tested for radiometric flux and wavelength at a drive current of 500 mA, 20 ms single pulse at 25° C and placed into one of the following radiometric flux (FF) and wavelength (WWW) bins. The LEDs can also be driven at other drive currents, to achieve the correlated flux values listed in the table.

### Radiometric Flux Bins

Flux Bin (FF)	Minimum Flux (mW) 500 mA, 25° C	Maximum Flux (mW) 500 mA, 25° C	Correlated Minimum Flux (mW) at 25° C		
			350 mA	650 mA	800 mA
DE	100	120	68	129	157
FA	120	140	82	155	188
FB	140	160	95	181	220
FC	160	180	108	206	251
FD	180	200	122	232	282

*Note 1: Product lifetime is a function of drive current. Sustained operation at absolute maximum current of 800 mA will result in a reduction of device lifetime compared to typical forward drive currents (350 mA-500 mA). Actual device lifetimes will also depend on junction temperature. Contact Luminus for information on product lifetime.*

*Note 2: Correlated minimum flux values are for reference only. XFM-5050s are tested and binned only at the test current of 500 mA.*

### Wavelength Bins

Wavelength Bin (WWW)	Minimum Wavelength (nm)	Maximum Wavelength (nm)
270	270	275
275	275	280

*Note: Luminus maintains a +/- 6% tolerance on flux measurements and +/- 1 nm on wavelength measurements.*

### Forward Voltage Bins

Voltage Bin	Minimum Voltage (V)	Maximum Voltage (V)
V13	10.0	10.5
V14	10.5	11.0
V15	11.0	11.5
V16	11.5	12.0
V17	12.0	12.5
V18	12.5	13.0
V19	13.0	13.5
V20	13.5	14.0
V21	14.0	14.5
V22	14.5	15.0
V23	15.0	15.5

*Note: Individual bins are not orderable. Please refer to product ordering information on page 3 for a list of ordering part numbers.*

### Part Number Nomenclature

XFM — 5050 — <UV> — <B130> — <FFWWW-##>

Product Family	Package Type	Color	Package Configuration	Bin kit
XFM: UVC Surface Mount Package	5050: 5.0 mm x 5.0 mm	UV	B: 2-chip version 130: 130° emission angle	Flux (FF) and Wavelength(WWW) bin kit code See ordering informaton

### Ordering Part Numbers

The table below lists ordering part numbers available for XFM-5050-UV LEDs. The part number includes a bin kit, a group of flux and wavelength bins described in page 2, that are shippable for a given ordering part number. Individual flux or wavelength bins are not orderable . Flux bin listed is minimum bin shipped - higher bins may be included at Luminus' discretion.

Wavelength Range	Wavelength Bins	Radiometric Flux		Ordering Part Number
		Bin Kit Flux Code	Min. Flux (mW)	
270-280	270, 275	DE	100	XFM-5050-UV-B130-DE270-00
270-280	270, 275	FA	120	XFM-5050-UV-B130-FA270-00

### Optical and Electrical Characteristics

Parameter	Symbol	Typical	Unit
Test Current	$I_f$	500	mA
Minimum Forward Voltage	$V_{f-min}$	10.0	V
Typical Forward Voltage	$V_{f-typ}$	13.5	V
Maximum Forward Voltage	$V_{f-max}$	15.5	V
FWHM	$\Delta\lambda$	12	nm
Viewing Angle	$2\theta_{1/2}$	130	°
Thermal Resistance (junction-solder point)	$R_{th}$	3.1	°C/W

### Absolute Maximum Ratings

Parameter	Symbol	Value	Unit
Forward Current	$I_{f-max}$	800	mA
Junction Temperature	$T_j$	95	°C

Note 1: Ratings are based on operation at a constant junction temperature of  $T_j = 25^\circ\text{C}$ . Test conditions: 500 mA, 20 ms pulse at  $25^\circ\text{C}$ .

Note 2: XFM-5050-UV LEDs are designed for operation up to an absolute maximum forward drive current as specified above. Product lifetime data is specified at typical forward drive currents. Sustained operation at absolute maximum currents will result in a reduction of device lifetime compared to typical forward drive currents. Actual device lifetimes will also depend on junction temperature.

Note 3: Caution must be taken not to stare at the radiation emitted from UV LEDs.

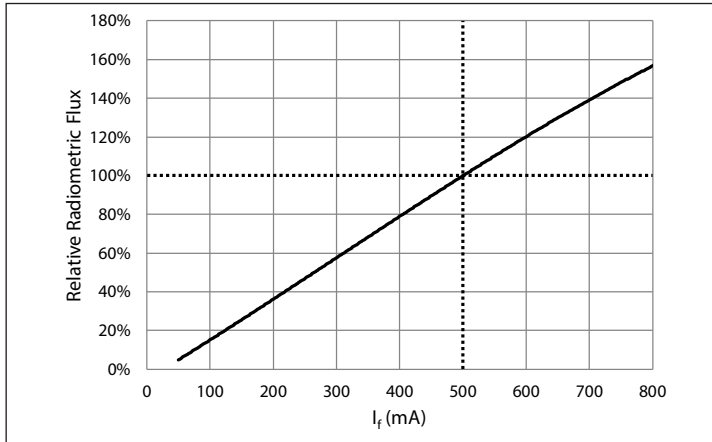
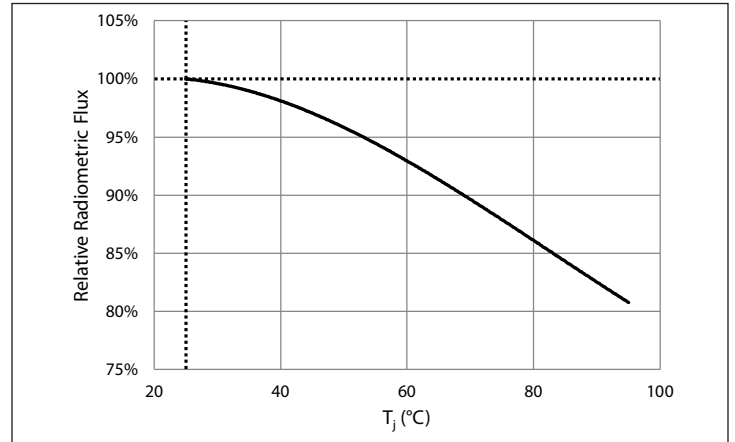
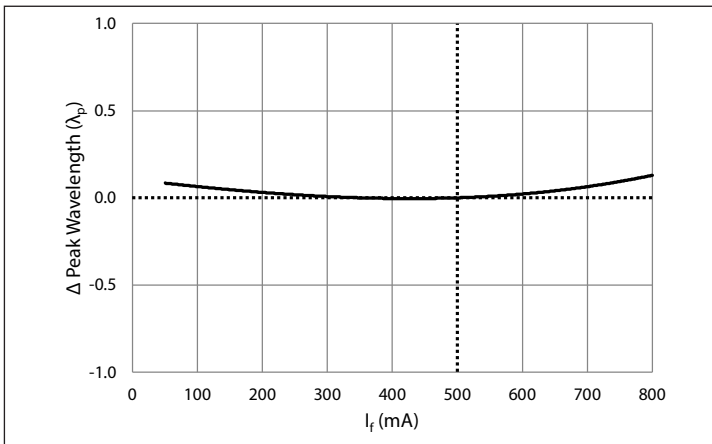
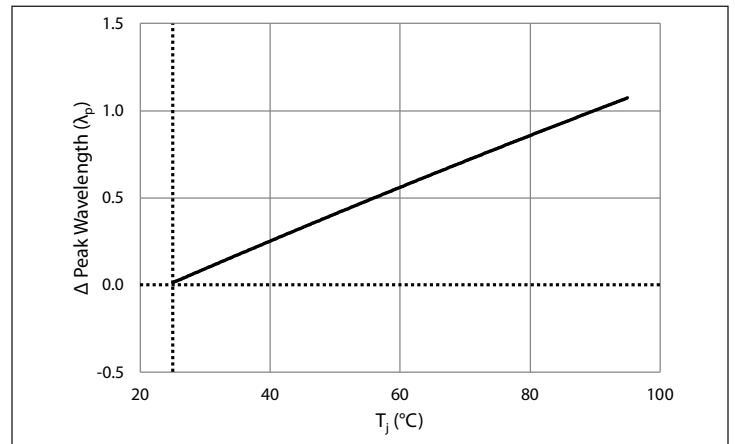
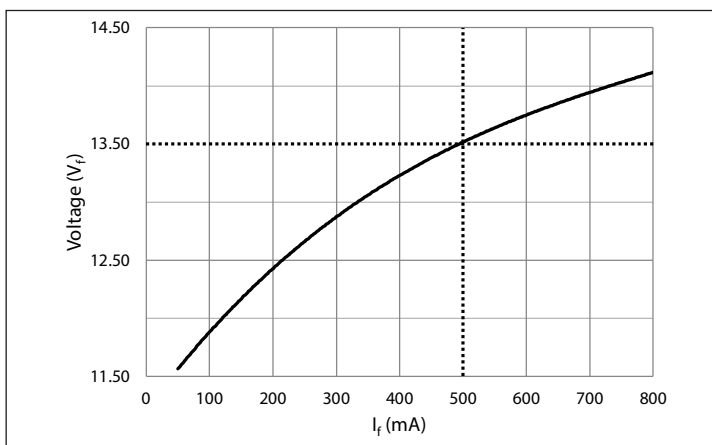
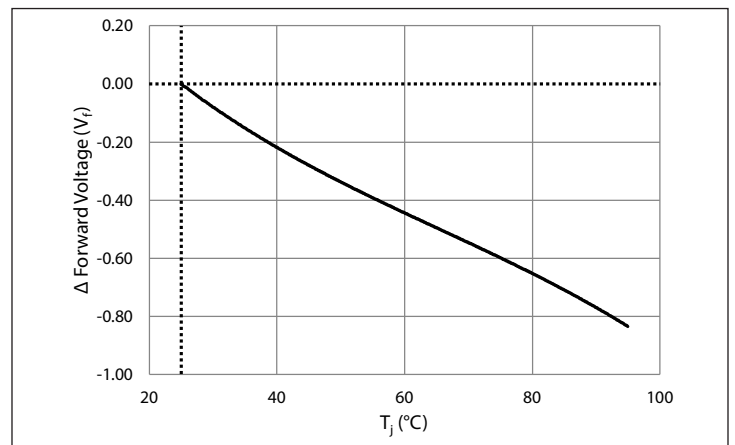
**Optical & Electrical Characteristics**
**Relative Power vs. Forward Current**
 $\phi/\phi_{(500\text{ mA})}$ , 20 ms pulse,  $T_j = 25^\circ\text{C}$ 

**Relative Power vs. Junction Temperature**
 $\phi/\phi_{(25^\circ\text{C})}$ , 20 ms pulse, 500 mA

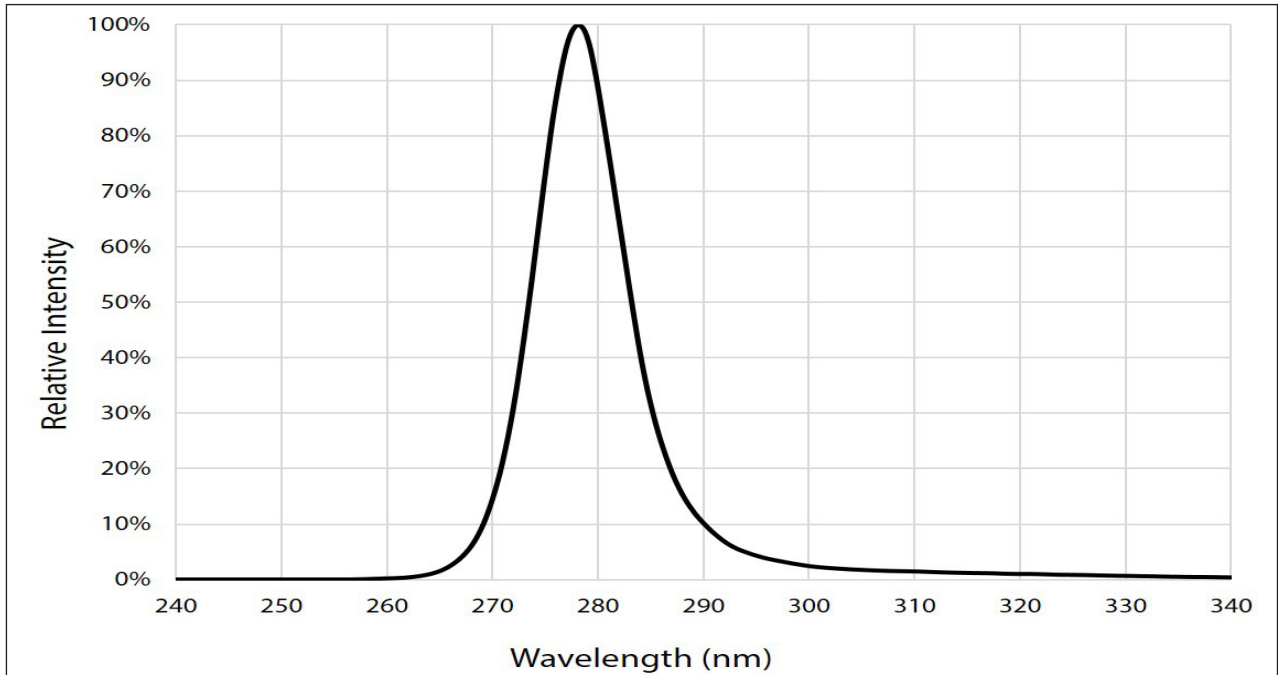
**Peak Wavelength Shift vs. Forward Current**
 $\lambda_p = \lambda_p(I_f) - \lambda_p(500\text{ mA})$ , 20 ms pulse,  $T_j = 25^\circ\text{C}$ 

**Peak Wavelength Shift vs. Junction Temperature**
 $\lambda_p = \lambda_p(T_j) - \lambda_p(25^\circ\text{C})$ , 20 ms pulse,  $I_f = 500\text{ mA}$ 

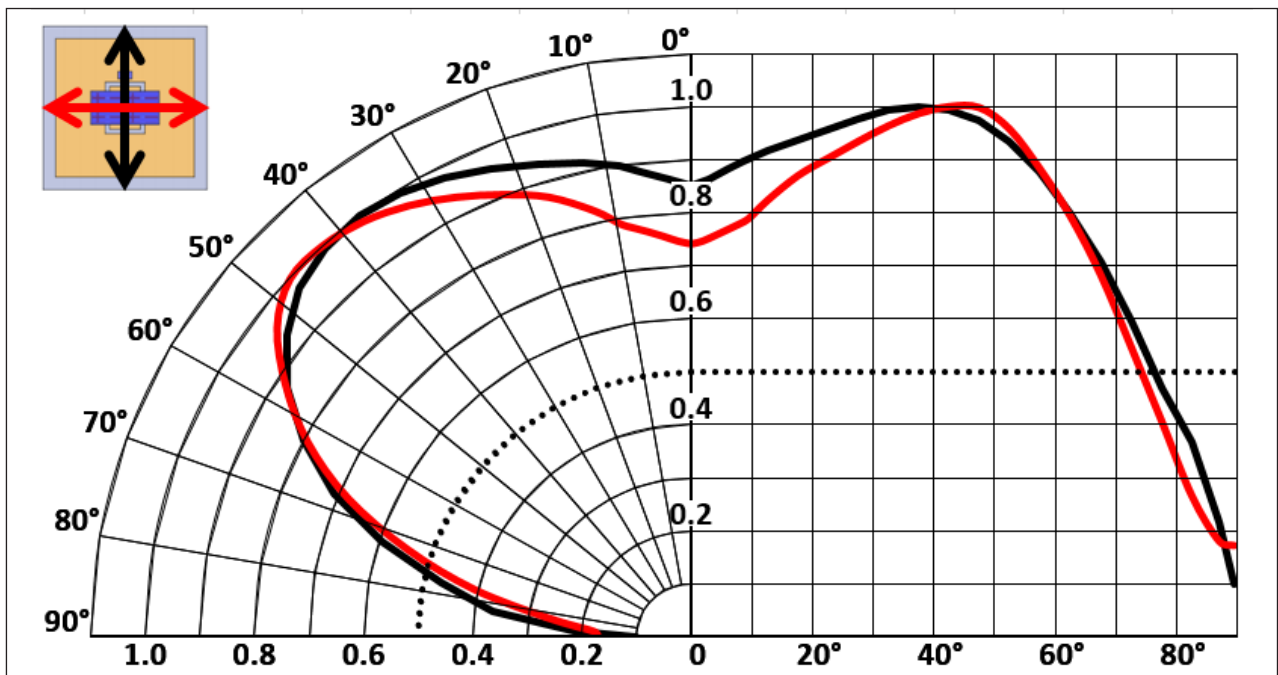
**Forward Voltage vs. Forward Current**
 $25^\circ\text{C}$ , 20 ms pulse

**Forward Voltage Shift vs. Junction Temperature**
 $\Delta V_f = V_f(T_j) - V_f(25^\circ\text{C})$ , 20 ms pulse,  $I_f = 500\text{ mA}$ 

### Typical Spectrum



### Radiation Pattern



**Mechanical Dimensions**

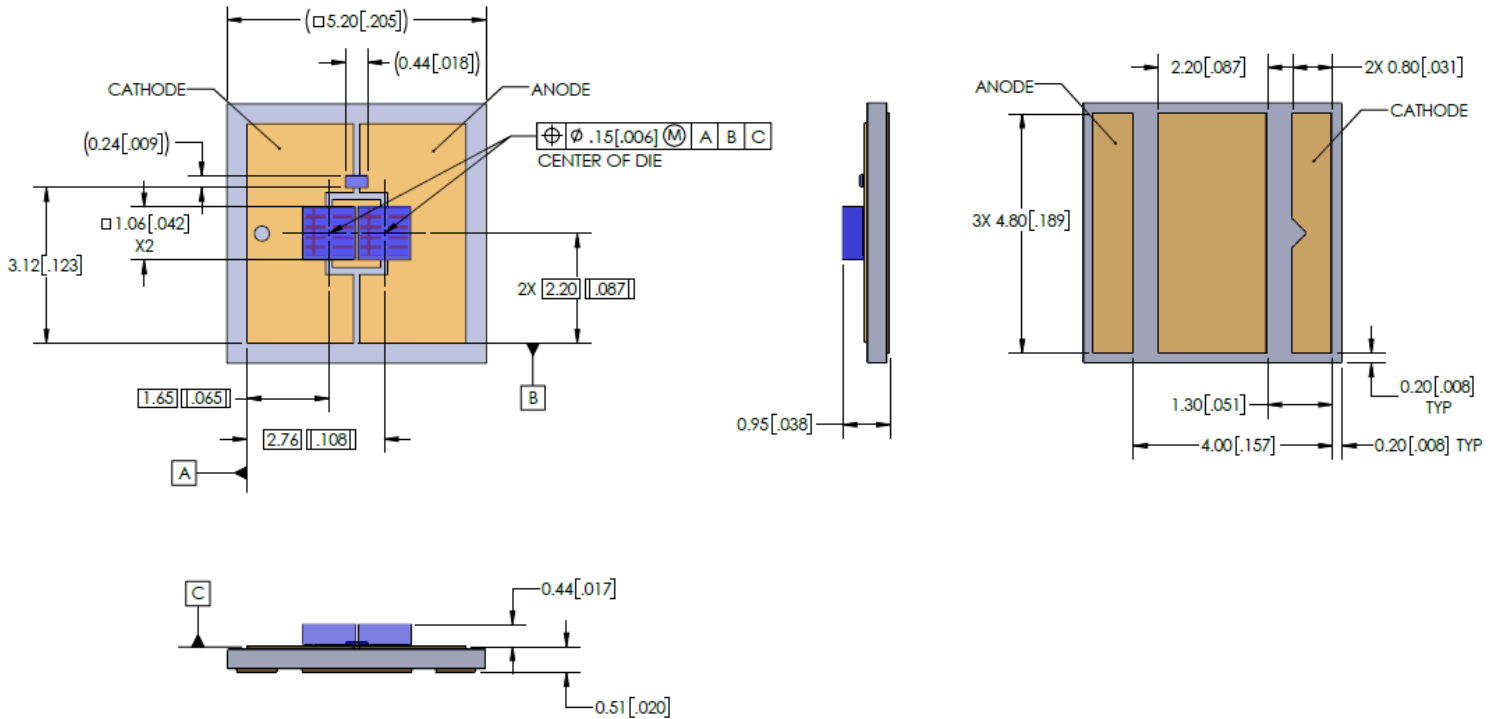

**Recommended Solder Pad & Stencil Pattern**

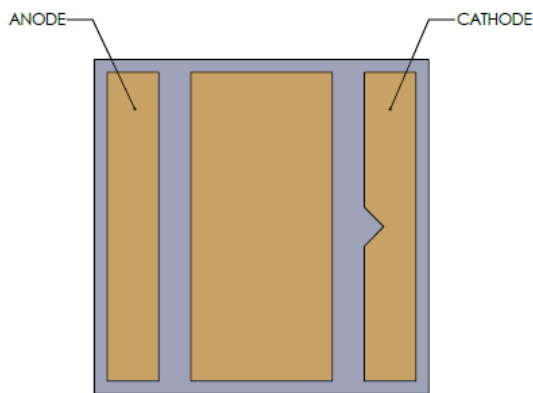

**DEVICE BOTTOM**

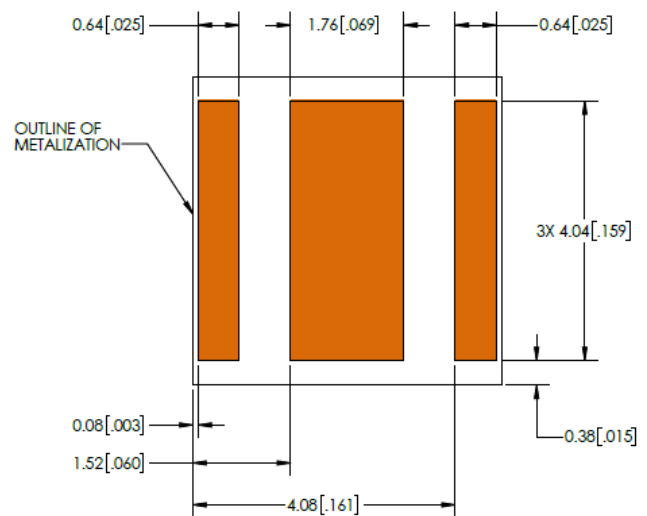

**STENCIL PATTERN**

### Soldering Profile

Profile Setting	Pb-Free Profile
Average Ramp-up Rate ( $T_{s_{max}}, T_p$ )	1 °C/sec
Preheat Temperature Min ( $T_{s_{min}}$ )	100-150 °C
Preheat Temperature Max ( $T_{s_{max}}$ )	180-200 °C
Preheat Time ( $t_{s_{min}}$ to $t_{s_{max}}$ )	60-120 sec
Liquidus Temperature ( $T_L$ )	217 °C
Time Maintained Above $T_L$ ( $t_L$ )	50-80 sec
Peak / Classification Temperature ( $T_p$ )	260 °C
Time within 5°C of Actual Peak Temp ( $t_p$ )	Max 10 sec
Ramp-Down Rate	2-3 °C /sec
25°C to Peak Temperature time	4 mins

Luminus recommends that users follow the recommended soldering profile provided by the manufacturer of the solder paste used. Note that this general guideline may not apply to all PCB designs and configurations.

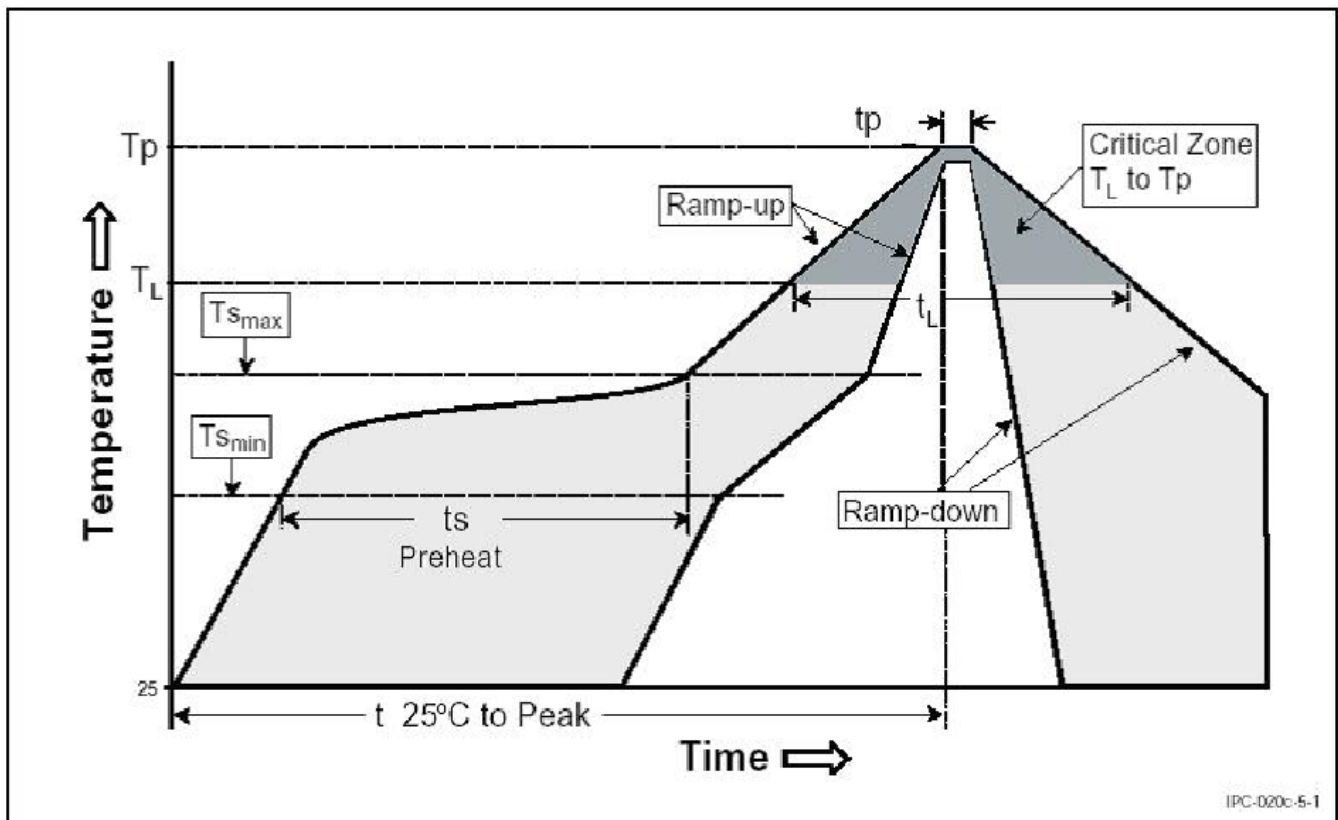



**Packing & Labeling**

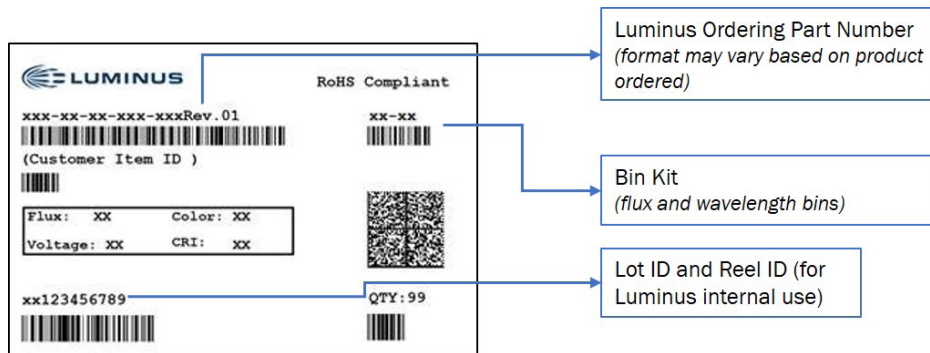
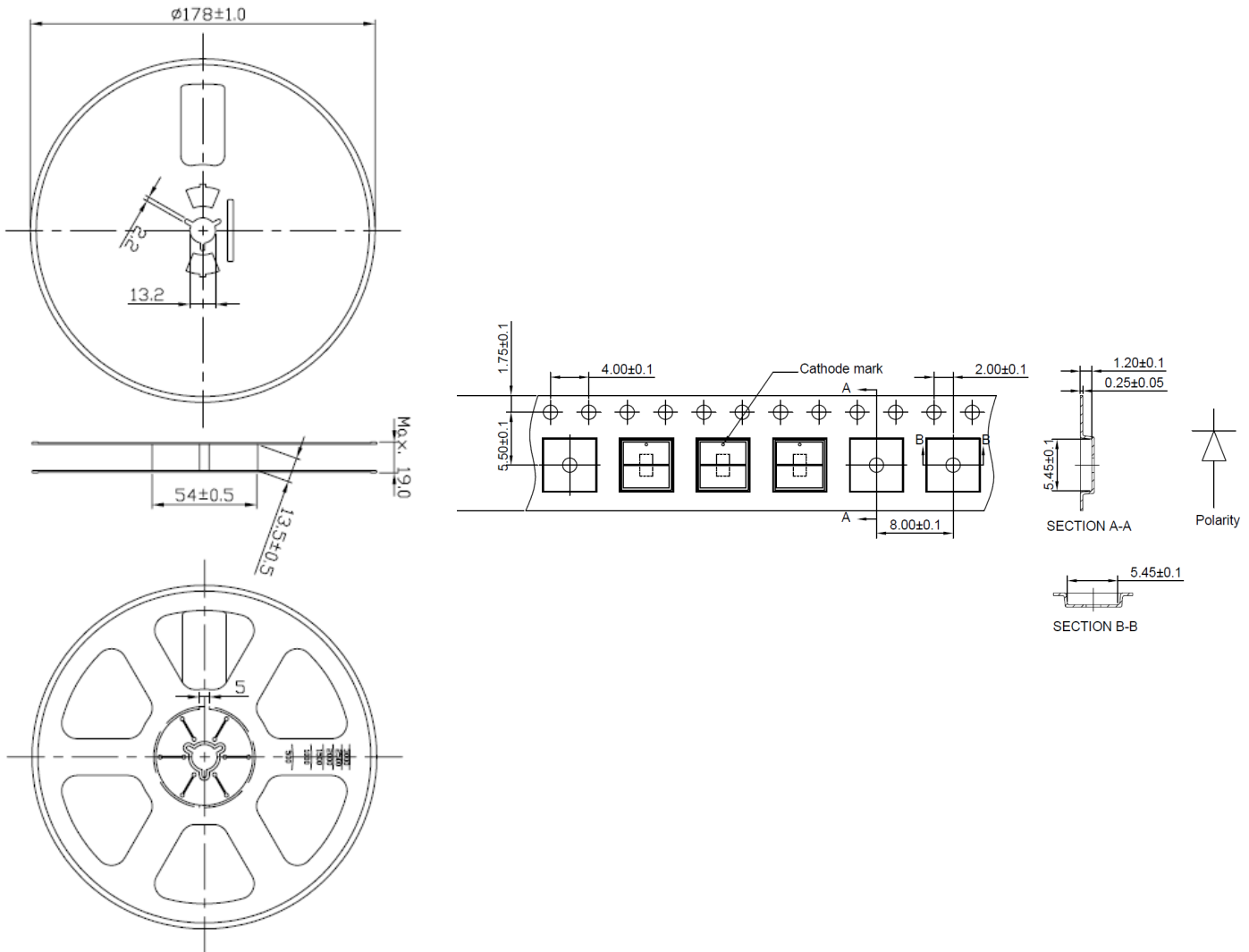

Note 1: Maximum of 250 pcs/reel. Lower quantities may be shipped.

Note 2: Minimum of 50 pcs/reel.

Note 3: Product complies to MSL 1.

## Precautions for storage, handling and use of UV LEDs

### 1. UV Light

XFM-5050-UV LEDs are short wavelength, deep UV LEDs. During operation, the LED emits high intensity UVC radiation, which is harmful to skin and eyes. UV light is also hazardous to skin and may cause cancer. Avoid exposure to deep UV light when LED is operational.

### 2. Static Electricity (ESD)

While XFM-5050 LEDs have built-in Zener protection diodes, they are particularly sensitive to ESD (Electrostatic Discharge). Static electricity and surge voltages seriously damage UV LEDs and can result in complete failure of the device. Anti-electrostatic wristband or gloves are recommended when handling the LEDs. All devices, equipment and machinery must be properly grounded and precautions must be taken against surge voltages.

Reference: APN-002815 Electrical Stress Damage to LEDs and How to Prevent It

### 3. Operating Conditions

In order to ensure the correct functioning of these LEDs, compliance to maximum allowed specifications is important. UV LEDs are particularly sensitive to drive currents that exceed the max operating specifications and may be damaged by such drive currents. The use of current regulated drive circuits is strongly recommended when operating these devices. Customers should also provide adequate thermal management to ensure LEDs do not exceed maximum recommended temperatures. Operating LEDs at temperatures in excess of specification will result in damage and possibly complete failure of the device.

### History of Changes

Rev		Description of Change
01	03/18/2021	Rev01 Release

