

XFM-5050-ES

6-chip UVC LED

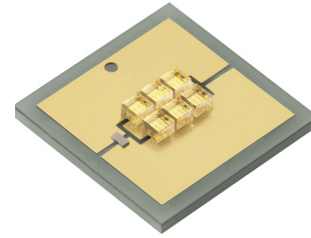

Features

- High power UVC LED: >130 mW output power at 275 nm
- Compact, cost effective 5050 package
- Designed to maximize irradiance in high flow applications
- Wide viewing angle >150 °
- Standard SMT process



Applications

- Air Purification
- Water Purification
- Surface Disinfection
- Medical Device Sterilization
- Food & Beverage Preparation

Table of Contents

Ordering Information.	2
Binning Structure.	3
Absolute Maximum Ratings	4
Device Performance	5
Angular distribution and Typical Spectrum.	7
Soldering Profile.	8
Mechanical Dimensions	9
Shipping Reel Outline	10
Shipping Label	11
Notes	12
Revision History.	13



Ordering Information

Ordering Part Numbers¹

Wavelength Range (nm)	Wavelength Bins	Radiometric Flux		Ordering Part Number
		Bin Kit Flux Code	Min. Flux (mW)	
270 - 280	270, 275	DE	100	XFM-5050-ES-UV-F150H-DE270-00
		FA	120	XFM-5050-ES-UV-F150H-FA270-00

Part Number Nomenclature

XFM	5050	UV	F150H	<FFWWW-##>
Product Family	Chip Area	Color	Package Configuration	Bin Kit
XFM: UVC Surface Mount Package	5050: 5.0 mm x 5.0 mm	UV: Ultraviolet	F150H: 6-chip, 150 deg viewing angle, Gen2	Flux and Wavelength bin kit code - See ordering information

Note:

1. Flux Bin listed is minimum bin shipped, higher bins may be included at Luminus' discretion.



Binning Structure

XFM-5050-ES-UV LEDs are tested for radiometric flux and wavelength at a drive current of 300 mA, 20 ms single pulse at 25°C and placed into one of the following radiometric flux (FF), wavelength (WWW) bins and forward voltage bins. The LEDs can also be driven at other drive currents, to achieve the correlated flux values listed in the table.

Radiometric Flux Bins^{1,2}

Color	Flux Bin ³	Binning @ 300 mA, T _c = 25°C ^{4,5}		Correlated Minimum Flux (mW), T _c = 25°C	
		Min. Flux (mW)	Max. Flux (mW)	450 mA	600 mA
UV	DE	100	120	139	175
	FA	120	140	167	210
	FB	140	160	195	245
	FC	160	180	223	280

Wavelength Bins²

Color	Wavelength Bin ^{3,6}	Binning @ 300 mA, T _c = 25°C ^{4,5}	
		Minimum Wavelength (nm)	Maximum Wavelength (nm)
UV	270	270	275
	275	275	280

Forward Voltage Bins

Color	Voltage Bin	Binning @ 300 mA, T _c = 25°C ^{4,5}	
		Minimum Voltage (V)	Maximum Voltage (V)
UV	V41	10.0	11.0
	V42	11.0	12.0
	V43	12.0	13.0

Note:

1. Luminus maintains a +/- 6% tolerance on flux measurements.
2. Products are production tested then sorted and packed by bin.
3. Individual bins are not orderable. Please refer to the Product Ordering information page for a list of orderable bin kits.
4. Product test condition: 300 mA, 20 ms pulse at 25 °C.
5. T_c= Case temperature.
6. The wavelength bin as marked on the product label may be followed by a letter which is for internal use only.



Absolute Maximum Ratings¹

Parameter	Symbol	Value	Unit
Forward Current	$I_{f \max}$	600	mA
Storage Temperature	$T_{s \min}$	-40	°C
	$T_{s \max}$	100	
Junction Temperature	$T_{j \max}$	100	°C
ESD sensitivity ANSI/ESDA/JEDEC JS-001 (HBM, Class 3B)	V_{ESD}	8000	V

Note:

1. XFM-5050-ES-UV LEDs are designed for operation up to an absolute maximum forward drive current as specified above. Product lifetime data is specified at typical forward drive currents. Sustained operation at absolute maximum currents will result in a reduction of device lifetime compared to typical forward drive currents. Actual device lifetimes will also depend on junction temperature.



Device Performance^{1,2}

Optical and Electrical Characteristics	Symbol	Value	Unit
Test Current	I_f	300	mA
Forward Voltage	$V_{f\min}$	10.0	V
	$V_{f\text{typ}}$	11.64	
	$V_{f\max}$	13.0	
FWHM	$\Delta\lambda$	11	nm
Viewing Angle	$2\theta_{1/2}$	150	°
Thermal Characteristics			
Thermal Resistance (junction to case) ³	$R_{\theta j-c}$	4.2	°C/W

Note:

1. Ratings are based on operation at a constant temperature of $T_c = 25^\circ\text{C}$. Test conditions: 300 mA, 20 ms pulse at 25°C .
2. XFM-5050-ES-UV LEDs are short wavelength, deep UV LEDs. During operation, the LED emits high intensity UVC radiation, which is harmful to skin and eyes. UV light is also hazardous to skin and may cause cancer. Avoid exposure to deep UV light when LED is operational.
3. Measurements are in accordance with JEDEC 51-14. For more about thermal resistance calculation, please see <https://luminusdevices.zendesk.com/hc/en-us/articles/4416807960717-Thermal-Heatsink-Required-Rth-Calculator>



Relative Radiometric Flux

Forward current: $\phi_v/\phi_v(300\text{ mA})$, 20 ms pulse, $T_c = 25^\circ\text{C}$

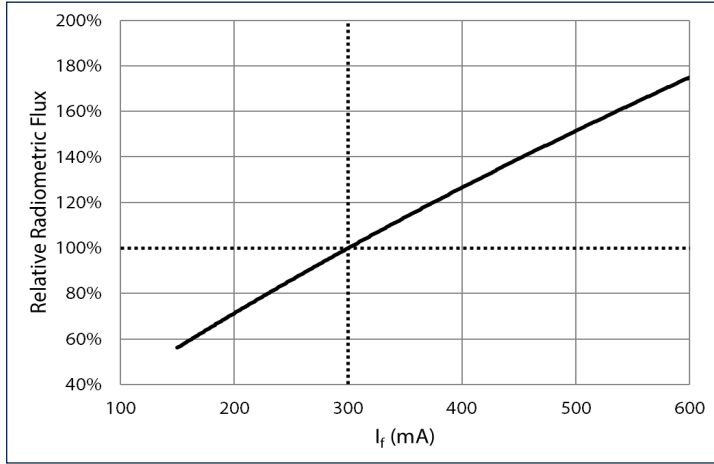

Temperature: $\phi_v/\phi_v(25^\circ\text{C})$, 20 ms pulse, $I_f = 300\text{ mA}$

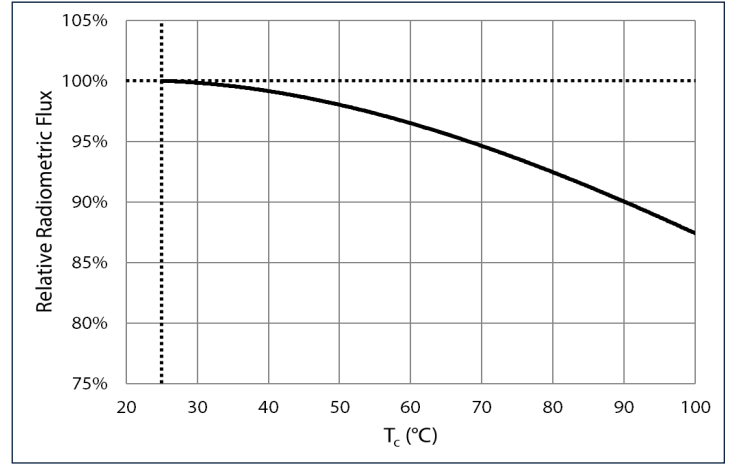

Forward Voltage Shift

Forward current: $\Delta V_f = V(I_f) - V(300\text{ mA})$, 20 ms pulse, $T_c = 25^\circ\text{C}$

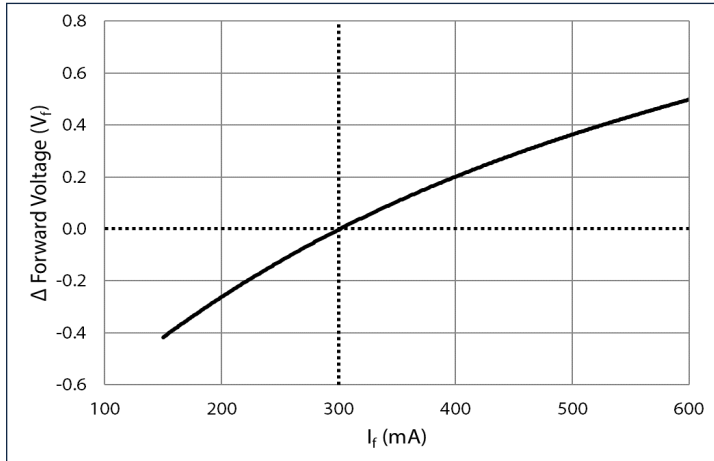

Temperature: $\Delta V_f = V(T_c) - V(25^\circ\text{C})$, 20 ms pulse, $I_f = 300\text{ mA}$

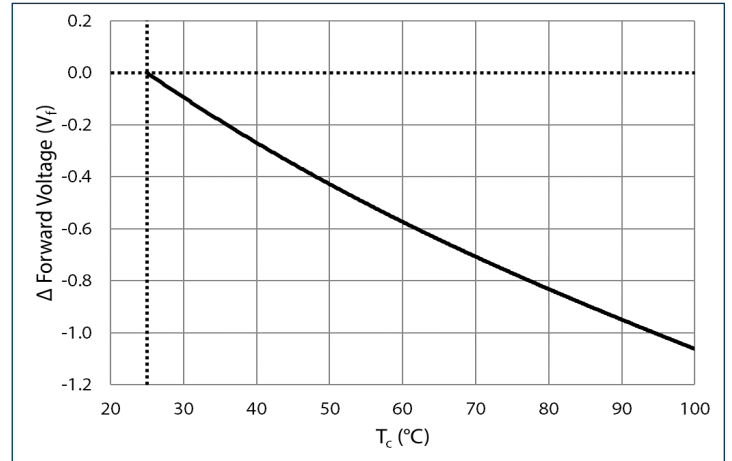

Peak Wavelength Shift

Forward current: $\Delta \lambda_d = \lambda_d(I_f) - \lambda_d(300\text{ mA})$, 20 ms pulse, $T_c = 25^\circ\text{C}$

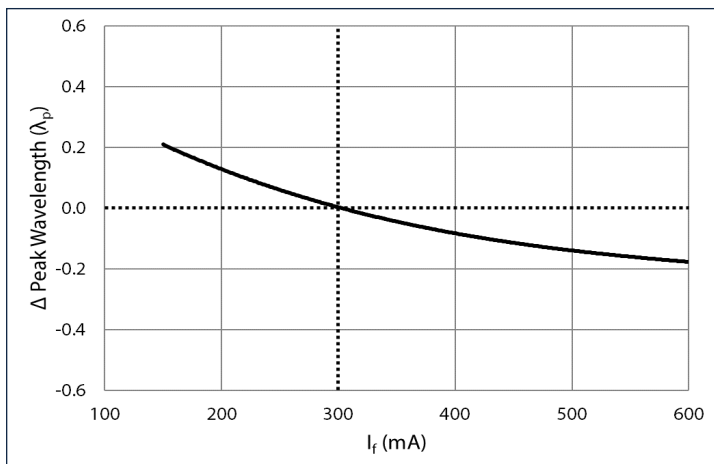

Temperature: $\Delta \lambda_d = \lambda_d(T_c) - \lambda_d(25^\circ\text{C})$, 20 ms pulse, $I_f = 300\text{ mA}$

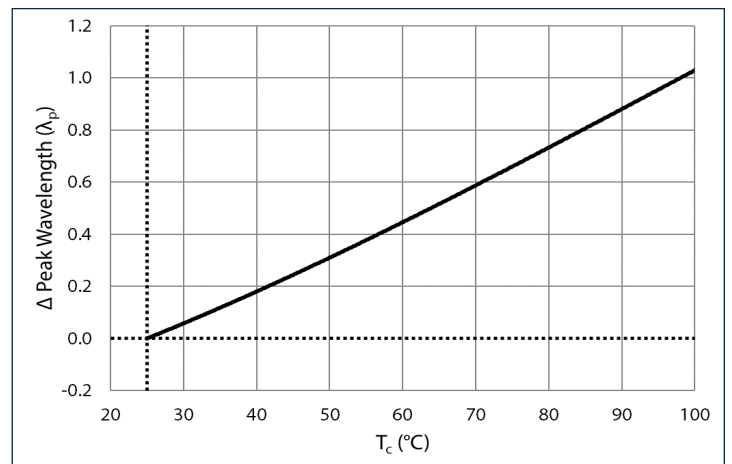



Angular distribution and Typical Spectrum

Angular distribution

$$I_{\text{ref}} = f(\Phi); T_c = 25^\circ\text{C}$$

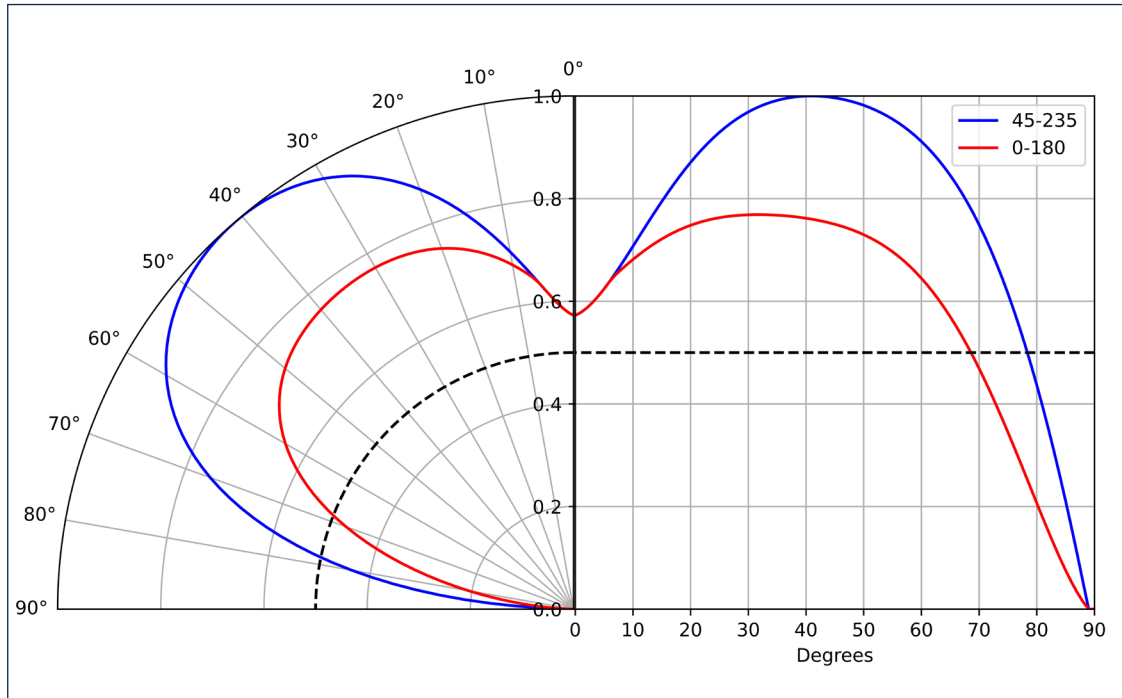

Typical Spectrum

$$\Phi_{\text{ref}} = f(\lambda); I_f = 300\text{mA}; T_c = 25^\circ\text{C}$$

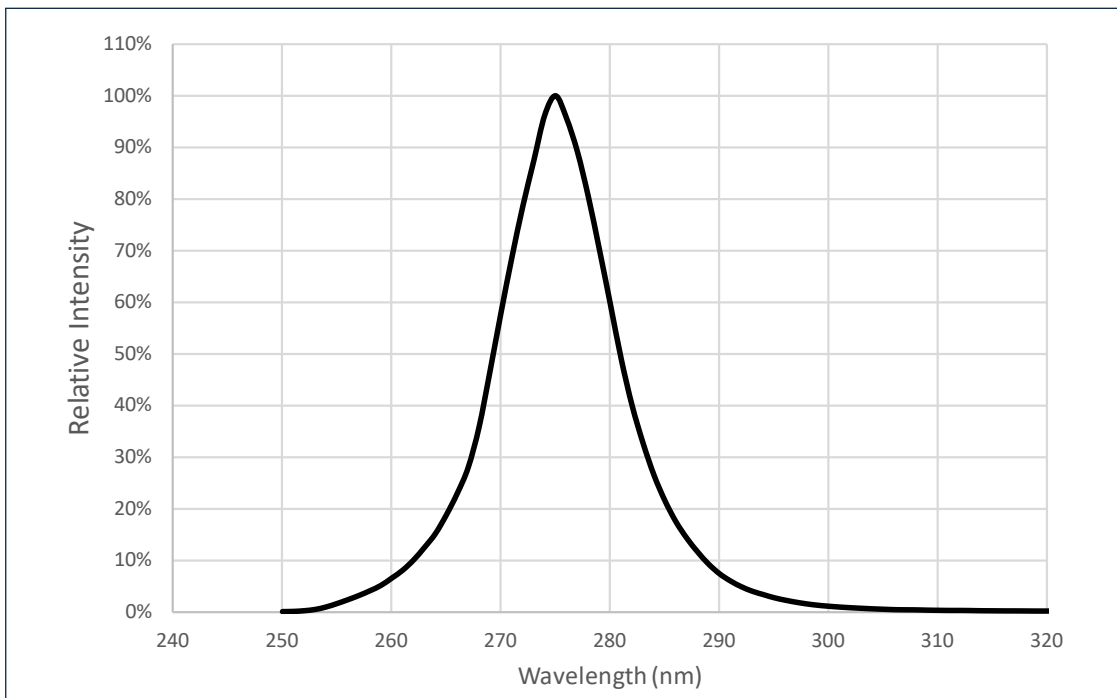



Soldering Profile

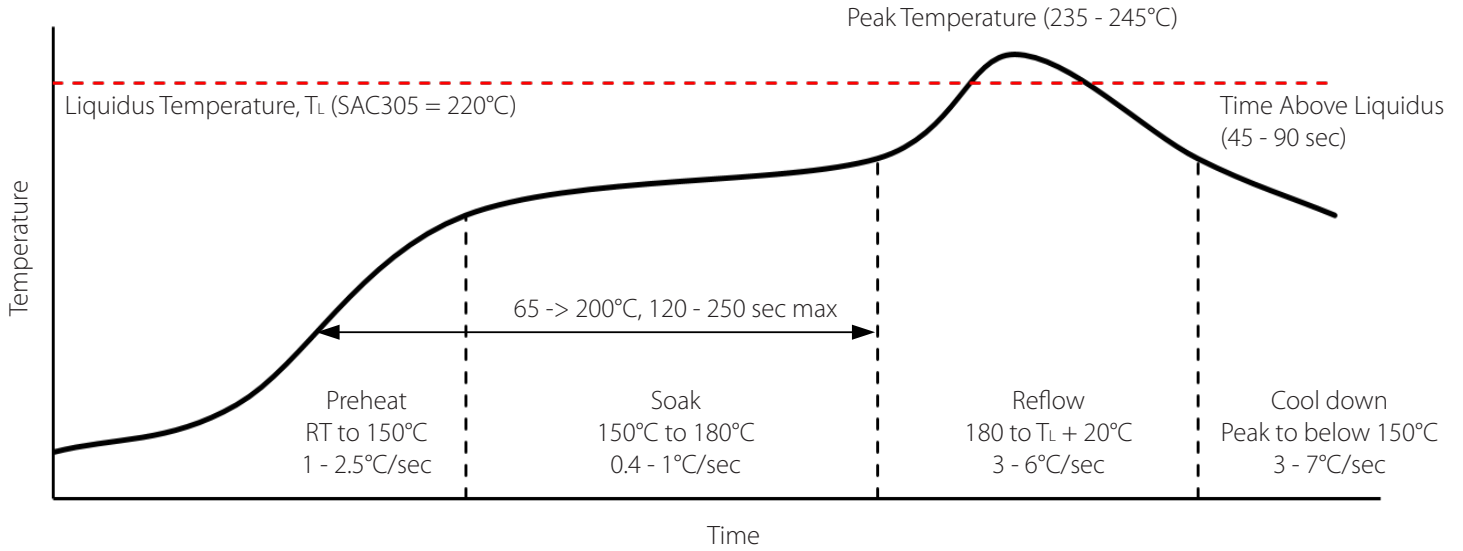

SMT Rework Guideline	Manual Hotplate Reflow	Hot Air Gun Reflow
Heating Time	< 60 sec	
Hotplate Temperature	< 245°C	< 150°C

Note:

- Product complies to Moisture Sensitivity Level TBA.
- The numbers in the table are specific to SAC305. Luminus recommends using an SAC305 solder paste with a no-clean flux for RoHS compliant products.
- During the pick and place process, ensure the pick-up tool does not touch any die components.
- Use of a multi-zone IR reflow oven with a nitrogen blanket is recommended.
- Time-temperature profile of the reflow process showing the four functional profile zones are defined in IPC-7801. Temperature is referenced to the center of the PCB.
- Luminus recommends to use the solder paste data sheet information as a starting point in time-temperature process development.
- These are general guidelines. Consult the solder paste manufacturer's datasheet for guidelines specific to the alloy and flux combination used in your application.
For more information, please refer to:
<https://luminusdevices.zendesk.com/hc/en-us/articles/360060306692-How-do-I-Reflow-Solder-Luminus-SMD-Components->
- For any technical questions about soldering process, please contact Luminus at techsupport@luminus.com.



Shipping Reel Outline

All XFM-5050 products are packaged and labeled with their respective bin as outlined in the tables on page 3.

Each reel will only contain one flux and one wavelength bin.

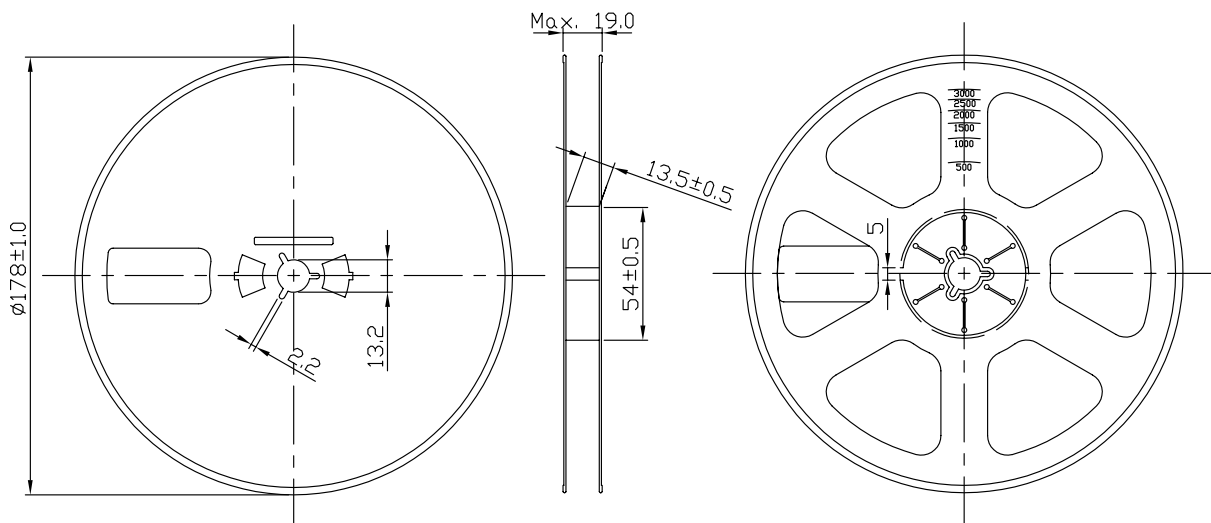
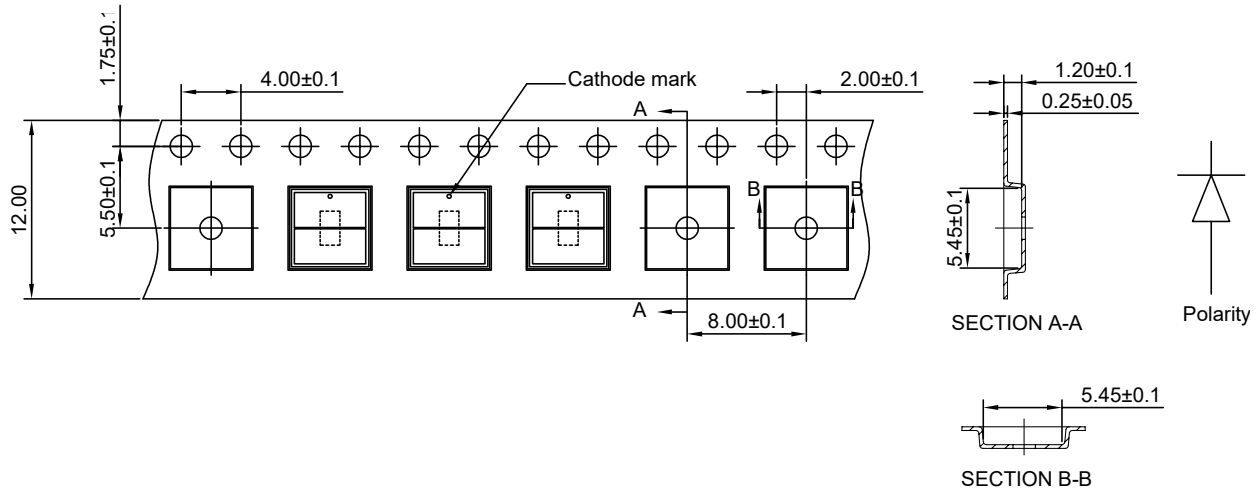



Shipping Label

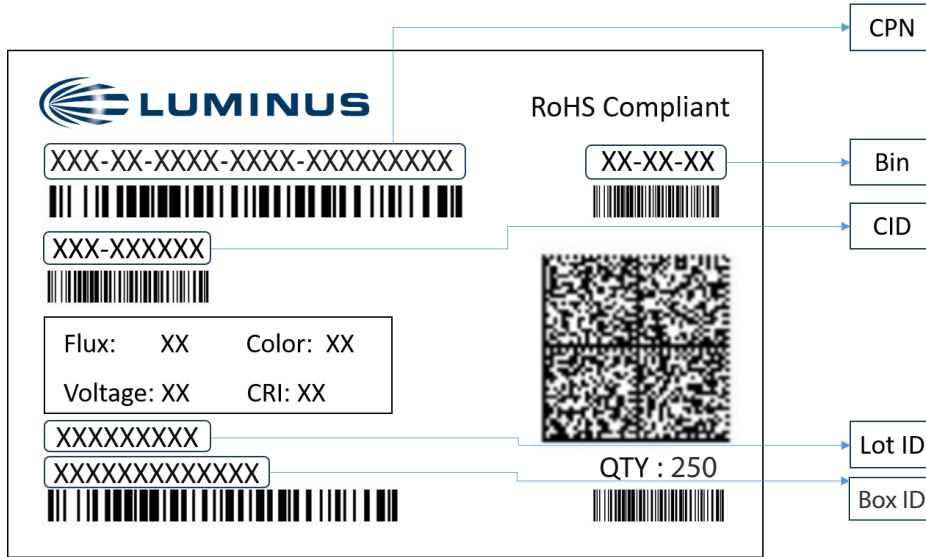

Label Fields:

- CPN: Luminus ordering part number
- CID: Customer's part number
- QTY: Quantity of devices in pack
- Flux: Bin as defined on page 3
- Wavelength: Bin as defined in page 3
- Voltage: Bin as defined on page 3
- Color: Bin as defined on page 3
- CRI: NA

Packing Configuration:

- Maximum of 250 devices per reel, minimum of 50 devices per reel
- Partial reel may be shipped
- Each reel is enclosed in anti-static bag
- Shipping label is placed on top of anti-static bag



Notes

Static Electricity

This product is sensitive to static electricity, and care should be taken when handling them. Static electricity or surge voltage will damage the LEDs. It is recommended to wear an anti-electrostatic wristband or anti-electrostatic gloves when handling the LEDs. All devices, equipment and machinery must be properly grounded. It is recommended that measures be taken to isolate LED processing equipment from potential sources of voltage surges.

Reference: APN-002815 Electrical Stress Damage to LEDs and How to Prevent It

Eye Safety

According to the test specification risk group IEC 62471: 2008-Non-GLS under 600 mA, this product complies to Risk group 3 (RG3) High risk, exceed the limits for Risk Group 2.

Warning: This product emits invisible light - there is no aversion response.

Avoid eye and skin exposure to un-shielded product.

For more information, please refer to: <https://luminusdevices.zendesk.com/hc/en-us/articles/10532958752397>



Revision History

Rev	Date	Description of Change
A	08/19/2022	Initial release
B	09/08/2022	Update product photo, characteristic curves, typical spectrum, angular distribution and editorial changes.
01	06/26/2023	Rev 01- Initial release