

Ultra High-Performance 2835 Mid Power LED

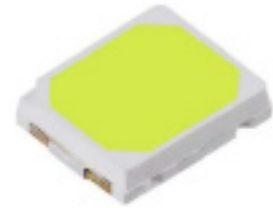

Table of Contents

Technology Overview2

Product Selection Table3

Operating Characteristics . .4

Chromaticity Diagram.....5

Color Ranks5

Chromaticity Coordinate Group
.....6

Characteristics Graphs.....7

Solder Profile8

Ordering Nomenclature...9

Package dimension 10

Soldering Pad Pattern 10

Dimension and Polarity... 11

Package Dimensions... 12

Soldering Profile 13

Box Packaging 14

Features:

- High efficacy
- CRI Options: Minimum 80, 90
- Low thermal resistance
- Compatible with automatic placement equipment
- Compatible with infrared reflow solder process
- RoHs and REACH compliant

Applications

- Replacement lamps
- Panel lighting
- Down lights
- Architectural lighting

Technology Overview

Luminus mid power LEDs are lighting class solutions designed for high performance general lighting applications. These state-of-the-art LEDs allow illumination engineers and designers to develop lighting solutions with maximum efficacy, brightness and overall quality.

Reliability

Luminus mid power LED is one of the most reliable light sources in the world today. Having passed a rigorous suite of environmental and mechanical stress tests, including mechanical shock, vibration, temperature cycling and humidity, it is fully qualified for use in a wide range of high performance and high efficacy lighting applications.

REACH & RoHS Compliance

The Luminus MP-2835 Mid Power LED is compliant to the Restriction of Hazardous Substances Directive or RoHS.

Understanding Luminus Mid Power LED Test Specifications

Every Luminus LED is fully tested to ensure it meets the high quality standards customers have come to expect from Luminus products.

Testing Temperature

Luminus Mid Power products are measured at a case temperature of 25°C and placed into intensity, chromaticity and voltage bins as described herein.

Product Selection Table

 Test condition = 65 mA, $T_c=25\text{ }^\circ\text{C}$

Nominal CCT	Minimum CRI	Ordering Part Number	Minimum Flux @ 65mA (Lumens)	Typical Flux @65mA (Lumens)
2200K	80	MP-2835-12D2-22-80	28	30
	90	MP-2835-12D2-22-90	24	26
2700K	80	MP-2835-12D2-27-80	30	33.5
	90	MP-2835-12D2-27-90	26	28
3000K	80	MP-2835-12D2-30-80	32	35
	90	MP-2835-12D2-30-90	26	29.5
3500K	80	MP-2835-12D2-35-80	34	36
	90	MP-2835-12D2-35-90	28	30
4000K	80	MP-2835-12D2-40-80	34	37
	90	MP-2835-12D2-40-90	28	31
5000K	80	MP-2835-12D2-50-80	34	37
	90	MP-2835-12D2-50-90	28	31
5700K	80	MP-2835-12D2-57-80	34	37
	90	MP-2835-12D2-57-90	28	31
6500K	80	MP-2835-12D2-65-80	34	37
	90	MP-2835-12D2-65-90	28	31

Typical PPF and PPF/W Performance

 Test condition = 65 mA, $T_c=25\text{ }^\circ\text{C}$

Part Number	PF ($\mu\text{mol/s}$) 360-830nm	PF/W ($\mu\text{mol/J}$) 360-830nm	PPF ($\mu\text{mol/s}$) 400-700nm	PPF/W ($\mu\text{mol/J}$) 400-700nm
MP-2835-12D2-30-80	0.54	3.09	0.51	2.93
MP-2835-12D2-50-80	0.54	3.11	0.53	3.03

*Tolerance of measurements of the luminous flux is $\pm 7\%$

* Tolerance of measurements of the CRI is ± 2

*IFP condition with Pulse: Width $\leq 100\mu\text{s}$ Duty cycle $\leq 1/10$

MP-2835 Mid Power Operating Characteristics

Optical and Electrical Characteristics ($T_c=25^\circ\text{C}$)

Parameter	Symbol	Minimum	Typical	Maximum	Unit	Condition
Forward Voltage	V_f	2.6	2.69	2.9	V	$I_f=65\text{mA}$
Reverse Current	I_r			10	μA	$V_r=5\text{V}$
View Angle	$2\theta^{1/2}$		120		°	$I_f=65\text{mA}$
Thermal Resistance	R_{th}_{j-sp}		12		$^\circ\text{C}/\text{W}$	$I_f=65\text{mA}$
Electrostatic Discharge	ESD	1000			V	

Note 1: To prevent damage refer to operating conditions and derating curves for appropriate maximum operating conditions

Note 2: Maximum operating case temperature combined with maximum drive current defines the total maximum operating condition for the device. To prevent damage, please follow derating curves for all operating conditions.

Note 3: Mid power LEDs are designed for operation up to an absolute maximum forward drive current as specified above. Product lifetime data is specified at typical forward drive currents. Sustained operation at absolute maximum currents will result in a reduction of device lifetime compared to typical forward drive currents. Actual device lifetimes will also depend on case temperature. Refer to the current vs. case temperature derating curves for further information.

Note 4: Caution must be taken not to stare at the light emitted from these LEDs. Under special circumstances, the high intensity could damage the eye.

Absolute Maximum Ratings ($T_c=25^\circ\text{C}$)

Parameter	Symbol	Rating	Unit
Forward Current	I_f	400	mA
Pulse Forward Current	I_{fp}	600	mA
Power Dissipation	P_d	1160	mW
Reverse Voltage	V_r	5	V
Operating temperature	T_{opr}	-40~+85	$^\circ\text{C}$
Storage Temperature	T_{sta}	-40~+85	$^\circ\text{C}$
Junction Temperature	T_j	120	$^\circ\text{C}$
Soldering Temperature	T_{sld}	260 $^\circ\text{C}$ for 10 sec	

*IFP condition with Pulse: Width $\leq 100\mu\text{s}$ Duty cycle $\leq 1/10$

Color Bins target chromaticity @ $T_c=25\text{ }^\circ\text{C}$

Color Code	Center		Radius		Angle(deg)
	x	y	a	b	
22M5	0.5018	0.4153	0.012500	0.007000	53.00
27M5	0.4582	0.4099	0.013500	0.007000	53.42
30M5	0.4342	0.4028	0.013900	0.006800	53.13
35M5	0.4080	0.3916	0.015450	0.006900	54.00
40M5	0.3825	0.3798	0.015650	0.006700	53.43
50M5	0.3451	0.3554	0.013700	0.005900	59.37
57M5	0.3290	0.3417	0.011175	0.005500	58.35
65M5	0.3130	0.3290	0.011150	0.004750	58.34

Ellipse Definition

*Note: Tolerance of measurements of the chromaticity Coordinate is ± 0.005
 Chromaticity coordinates as per ANSI standard.

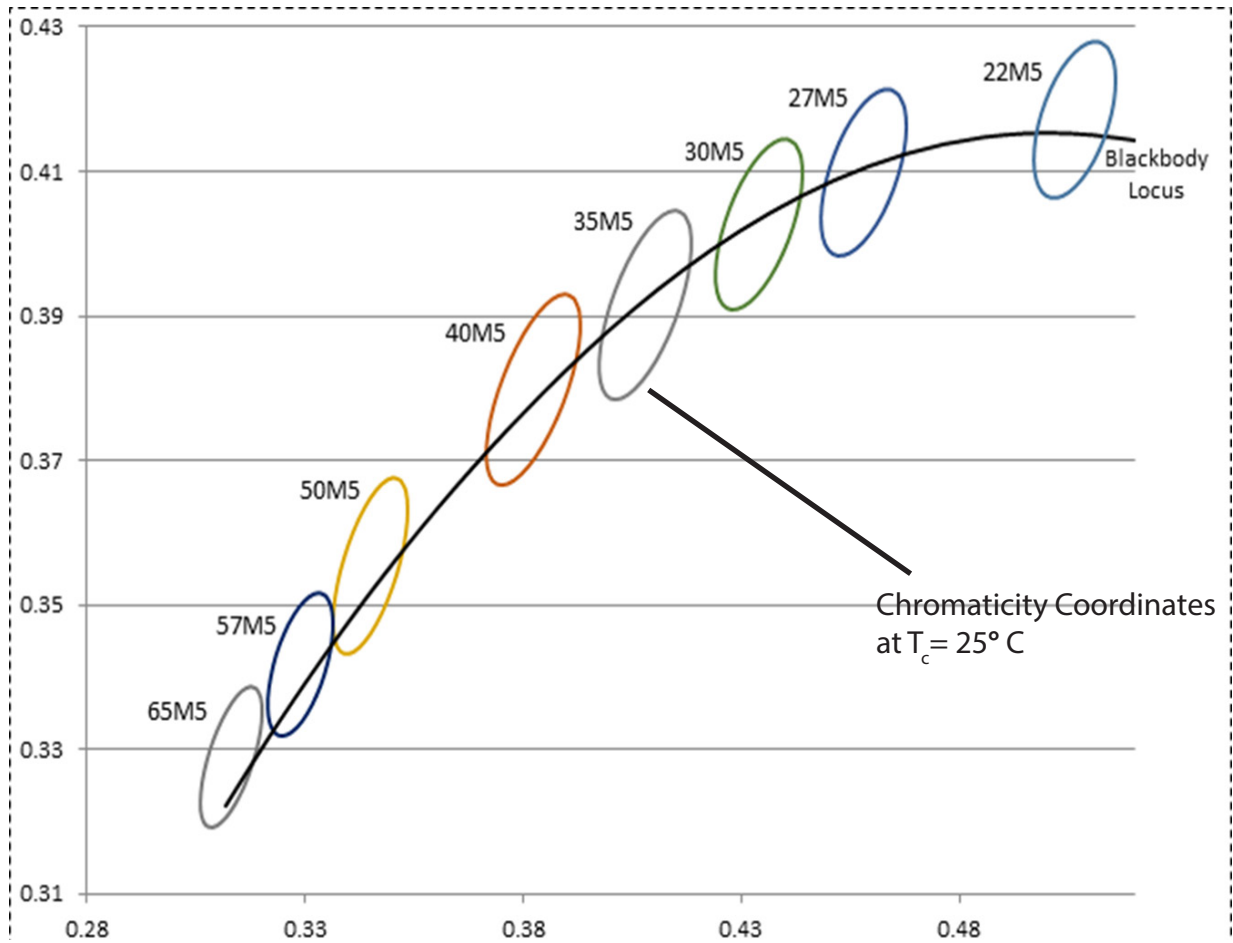
Chromaticity Coordinate Group

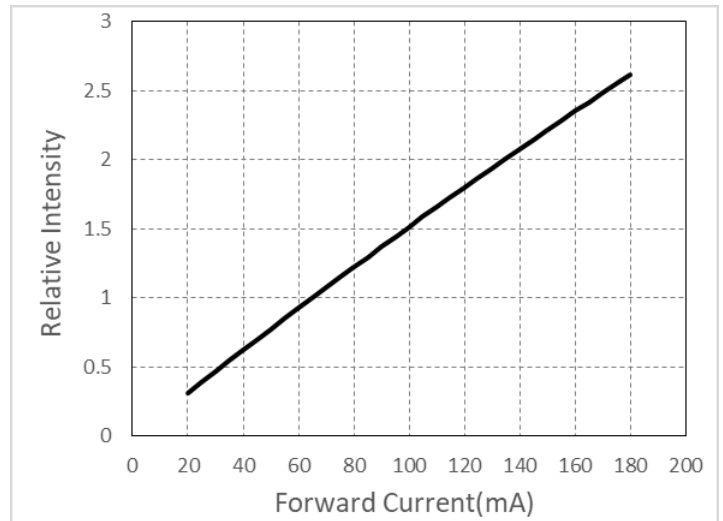
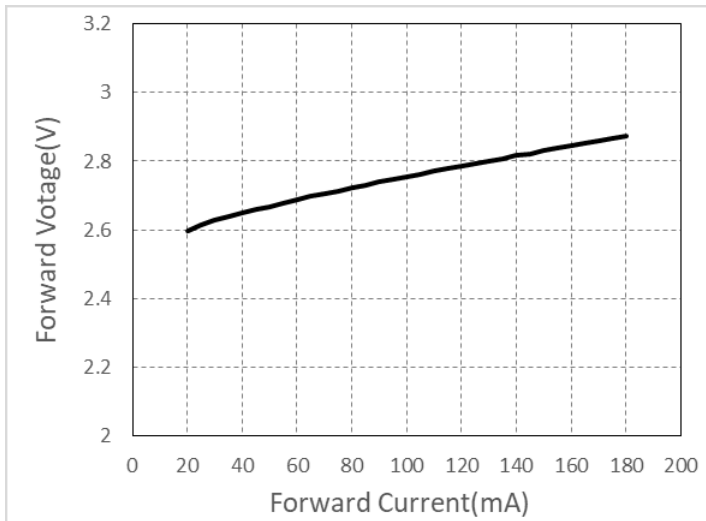
Typical optical/Electrical Characteristics Graphs
 V_f ----- I_f
 I_f ----- Relative Luminous flux

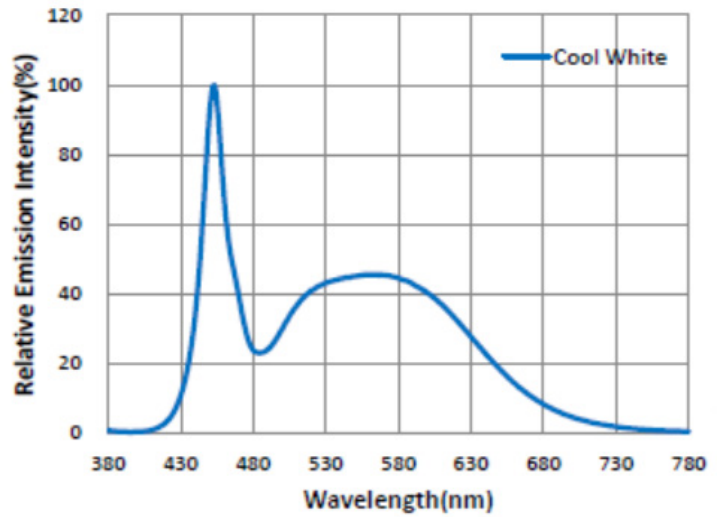
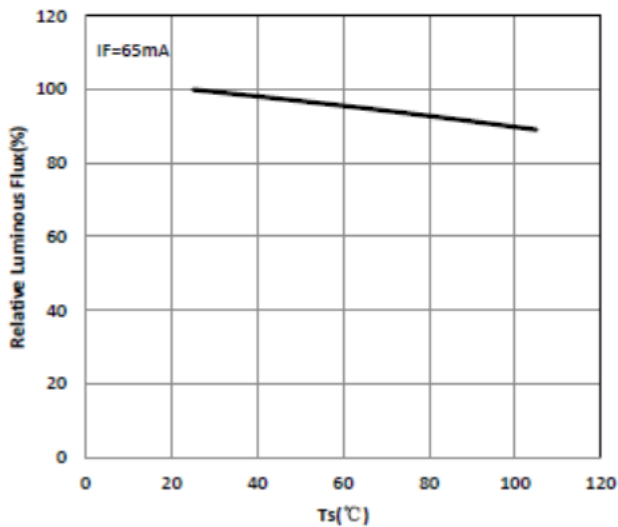
 T_c -----Relative Luminous Flux

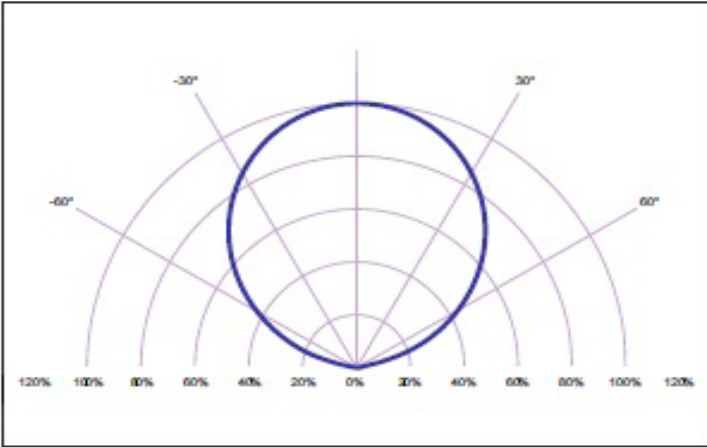
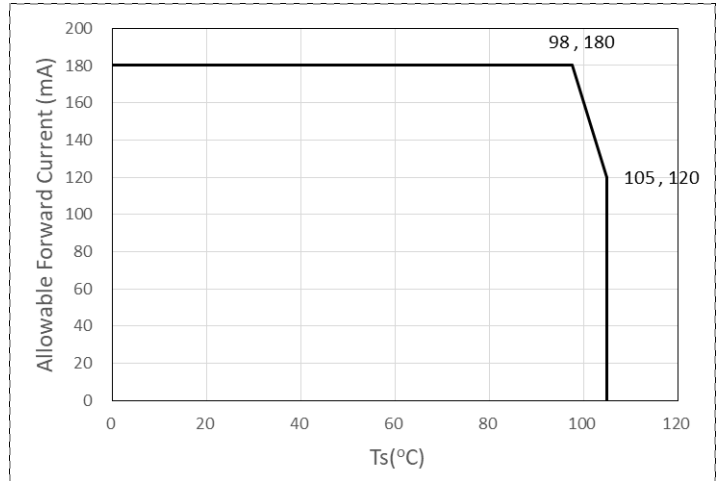
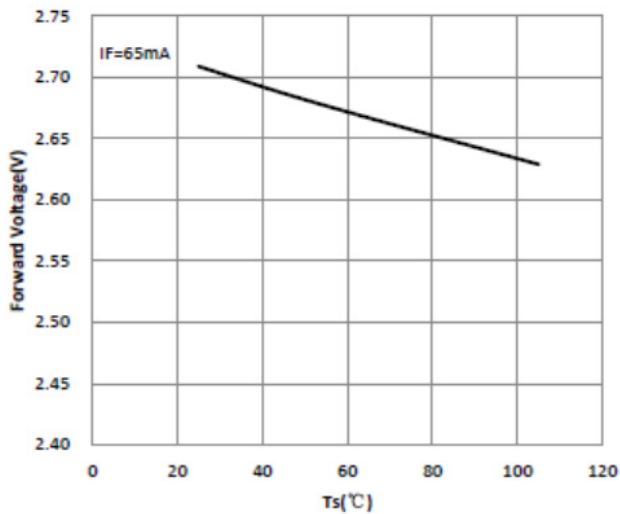
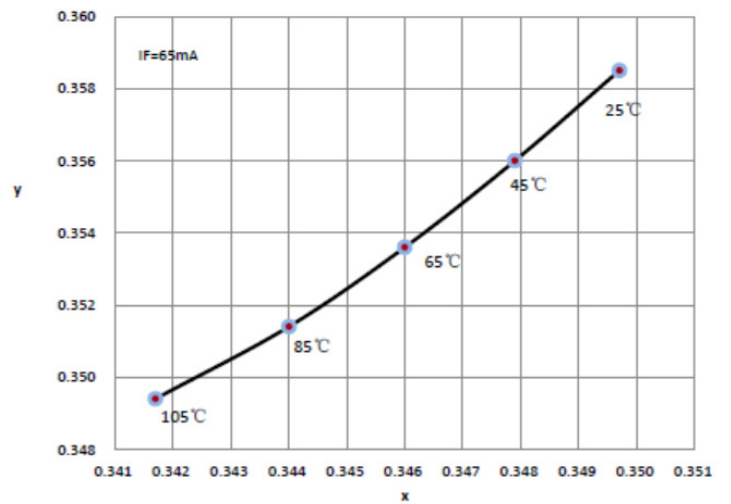
Color Spectrum

Typical Optical/Electrical Characteristic
Typical Polar Radiation Pattern

Solder Pad Temperature-Allowable Forward Current

T_c--Forward Voltage

Ta Cs CiE x, y Shift

Product Ordering and Shipping Part Number Nomenclature

All mid power products are packaged and labeled with part numbers as outlined in below. When shipped, each reel will contain only a single flux and voltage bin. The part number designation is as follows:

MP-2835 Mid Power LEDs

Mid Power	Package Type	Package Configurator	Nominal CCT	Minimum CRI
MP	MP-2835	12D2	##	##

Example:

The part number MP-2835-12D2-30-80 refers to a MP-2835 mid power emitter with nominal color temperature of 3,000k and minimum CRI of 80. Please refer to page 5 for a description of available CCT and CRI combinations.

Note 1: CCT Codes:

22 = 2200 k

27 = 2700 k

30 = 3000 k

40 = 4000 k

50 = 5000 k

57 = 5700 k

65 = 6500 k

Note 2: CRI Codes:

80

90

Each mid power product shipped will be labeled with its specific flux and voltage bins. Not all bins listed are available in all CCTs and CRIs. Test Condition = 65mA $T_c=25^\circ\text{C}$

Luminus Flux Bins

Bin Code	Minimum Flux (Lumens)	Maximum Flux (Lumens)
D5	24	26
D6	26	28
D7	28	30
D8	30	32
D9	32	34
E1	34	36
E2	36	38
EA	38	40
EB	40	42

Forward Voltage Bins ($T_c=25^\circ\text{C}$)

Bin Code	Minimum Voltage (Volts)	Maximum Voltage (Volts)
Z	2.6	2.7
A	2.7	2.8
B	2.8	2.9

*Tolerance of measurements of the Forward Voltage is $\pm 0.08\text{V}$

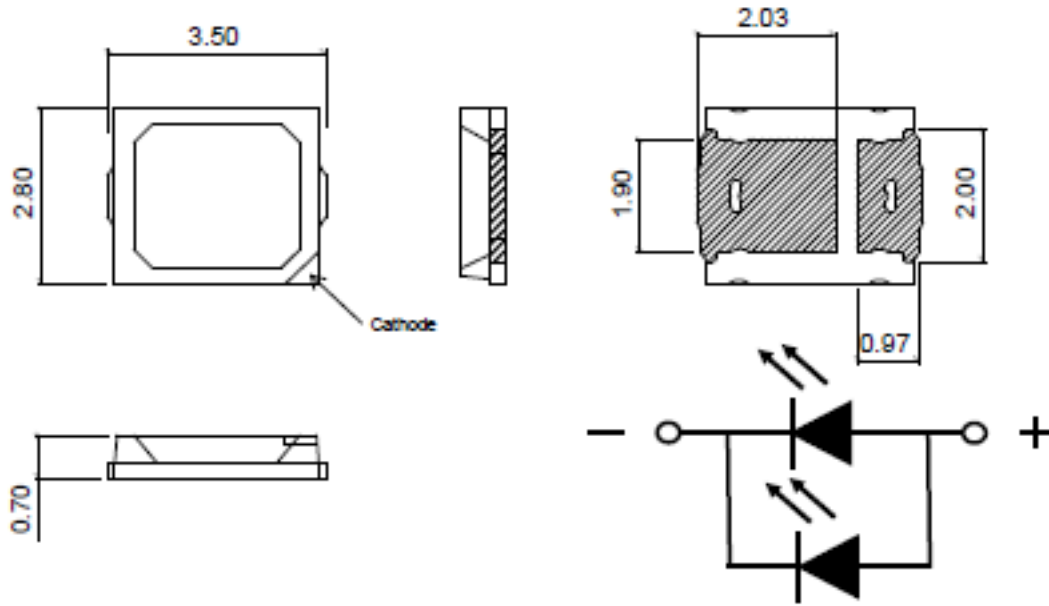
Package Dimension (mm)

* The tolerance unless mentioned is $\pm 0.1\text{mm}$, unit = mm

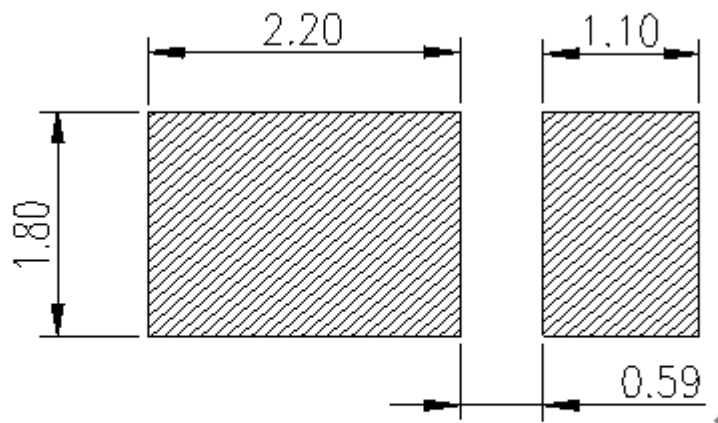
Recommended Soldering Pad Pattern
Recommended Solder Pad

*All dimensions are in millimeters

*Scale : 1:1

*This drawing without tolerances are for reference only

*Undefined tolerance: $\pm 0.10\text{mm}$

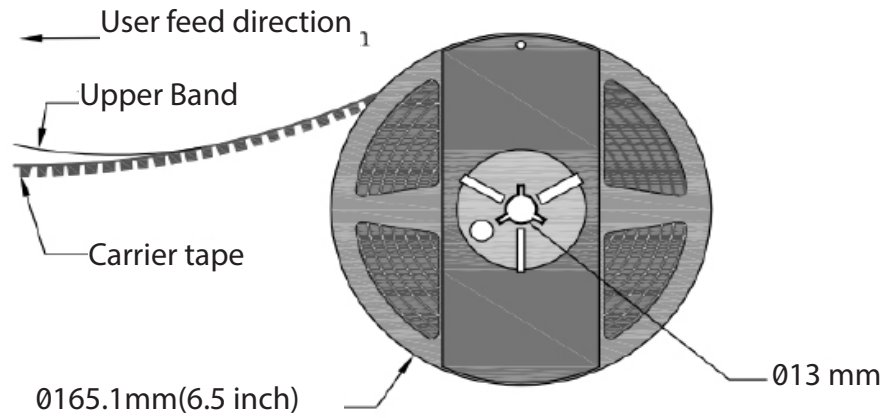
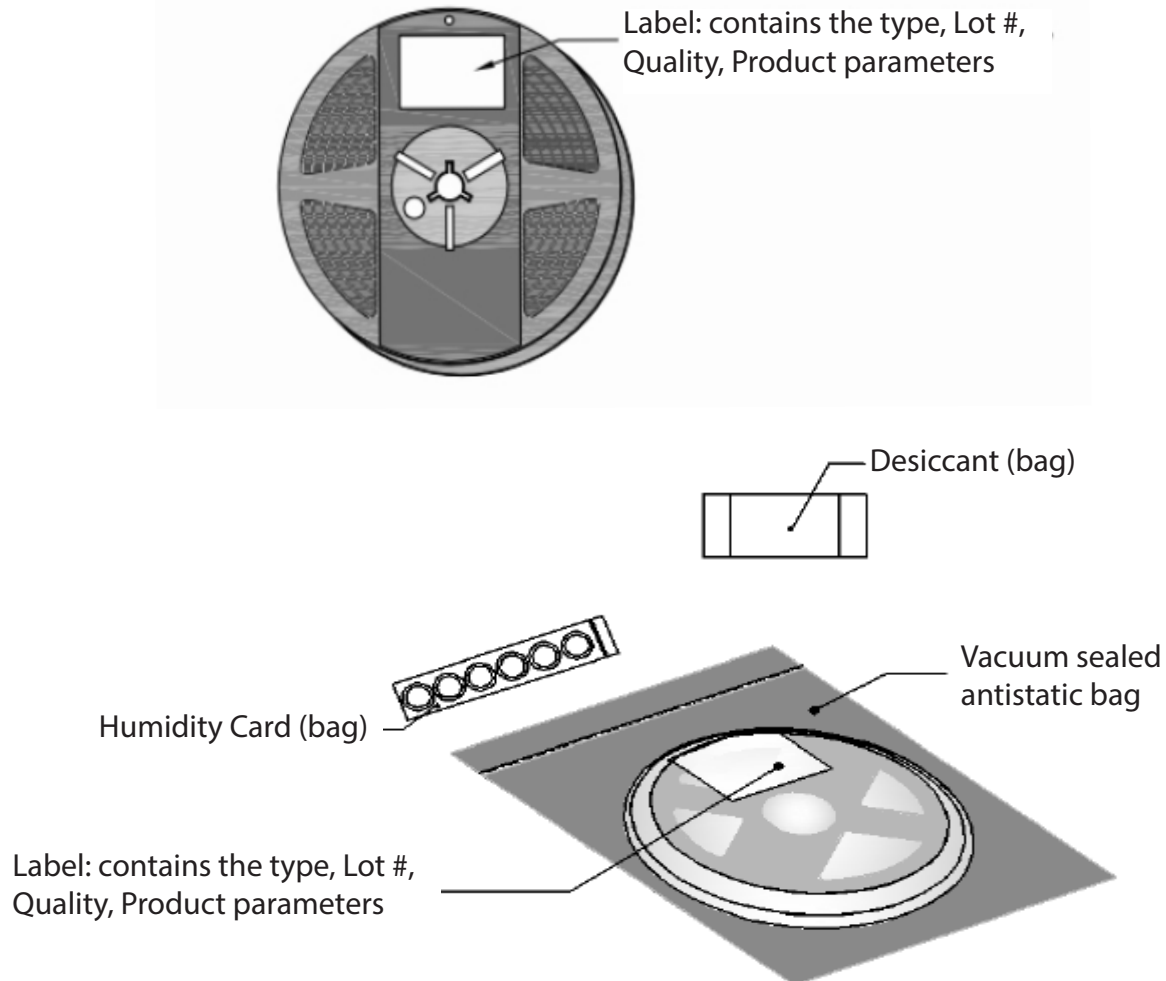
Package Dimensions of Reel (mm)

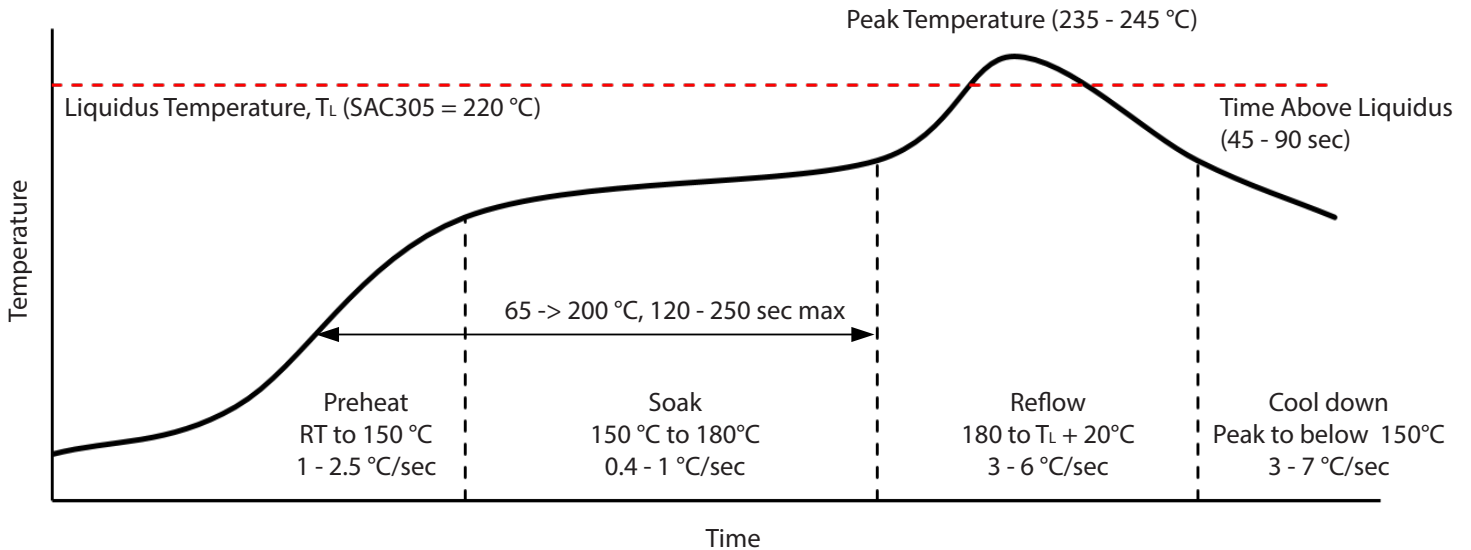
Package Dimensions of Reel (mm)

Solder Profile

SMT Rework Guideline	Manual Hotplate Reflow	Hot Air Gun Reflow
Heating Time	< 60 sec	

Note 1: Product complies to Moisture Sensitivity Level 3 (MSL 3).

Note 2: The numbers in the table are specific to SAC305. Luminus recommends using an SAC305 solder paste with a no-clean flux for RoHS compliant products.

Note 3: During the pick and place process, axial forces on the dome (or window) should not exceed 0.5 Newtons (N).

Note 4: Use of a multi-zone IR reflow oven with a nitrogen blanket is recommended.

Note 5: Time-temperature profile of the reflow process showing the four functional profile zones are defined in IPC-7801. Temperature is referenced to the center of the PCB.

Note 6: Luminus recommends to use the solder paste data sheet information as a starting point in time-temperature process development.

Note 7: These are general guidelines. Consult the solder paste manufacturer's datasheet for guidelines specific to the alloy and flux combination used in your application. For more information, please refer to:

<https://luminusdevices.zendesk.com/hc/en-us/articles/360060306692-How-do-I-Reflow-Solder-Luminus-SMD-Components->

Note 8: For any technical questions about soldering process, please contact Luminus at techsupport@luminus.com.

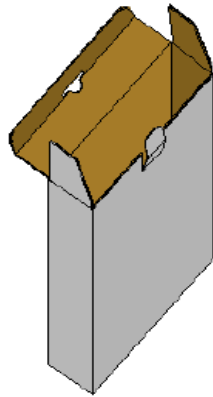
Box Packaging

*Capacity 5 reels per box

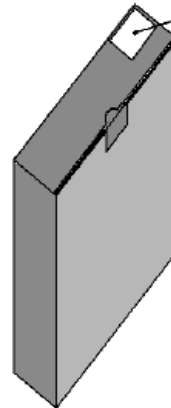

Label: Contains the Type, Lot #, Quality, Product parameters

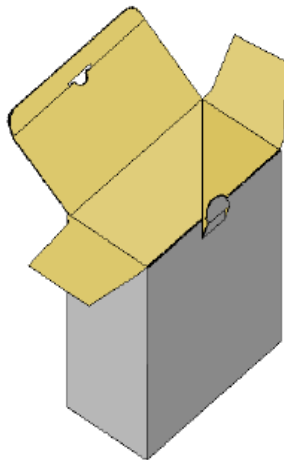



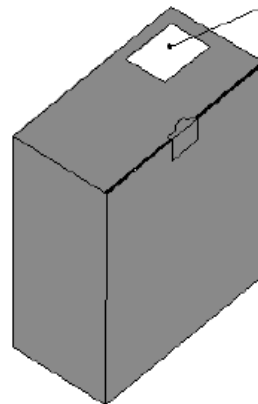

*Capacity 10 reels per box

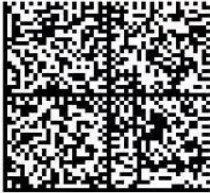

Label: Contains Type, Lot NO, Quantity, Product Parameters.
Label: contains the type, Lot #, Quality, Product parameters

Label

		RoHS Compliant	
MP-2016-1100-57-90-D3D4-M3		Rev.01	
			
Flux: D5	Color: 35MC		
Voltage: C	CRI: 80		
AB1961940			
10008		QTY: 5000	
			

Precaution for Use

Storage:

1. This device is rated at MSL 3 per JEDEC J-STD-020 standard.
2. Recommended storage condition:
At 5 °C- 30 °C and relative humidity 60% RH in its original package
3. After this bag is opened, devices that will be applied to infrared reflow, vapor - phase reflow, or equivalent soldering process must be:
 - a) Completed within 168 hours
 - b) Stored at less than 60%RH
 - c) If not completely used within 168 hours, seal the remaining in the moisture barrier bag
4. Devices require baking before mounting, if 3 a) is not met.
5. If baking is required, devices must be baked under below conditions:
24 hours at 60C+/-5C

Static Electricity:

1. The products are sensitive to static electricity, and care should be taken when handling them.
2. Static electricity or surge voltage will damage the LEDs. It is recommended to wear a anti-electrostatic wristband or an anti-electrostatic gloves when handling the LEDs.
3. All devices, equipment and machinery must be properly grounded. It is recommended that measures be taken against surge voltage to the equipment that mounts the LEDs.