

MP-5050-240H

Mid Power LED- Preliminary

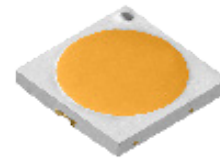

Table of Contents

Technology Overview	2
Product Selection Table	3
Operating Characteristics	4
Chromaticity Diagram	5
Color Ranks	5
Chromaticity Coordinate Group	6
Characteristics Graphs	7
Solder Profile	8
Ordering Nomenclature	9
Package dimension	10
Soldering Pad Pattern	10
Dimension and Polarity	11
Package Dimensions	12
Inner Box	13

Features:

- High efficacy
- Low thermal resistance
- Compatible with automatic placement equipment
- Compatible with infrared reflow solder process
- RoHs and REACH compliant

Applications

- | | |
|---------------------|--------------------------|
| • Replacement lamps | • Down lights |
| • Panel lighting | • Architectural lighting |

Technology Overview

Luminus mid power LEDs are lighting class solutions designed for high performance general lighting applications. These state-of-the-art LEDs allow illumination engineers and designers to develop lighting solutions with maximum efficacy, brightness and overall quality.

Reliability

Luminus mid power LED is one of the most reliable light sources in the world today. Having passed a rigorous suite of environmental and mechanical stress tests, including mechanical shock, vibration, temperature cycling and humidity, it is fully qualified for use in a wide range of high performance and high efficacy lighting applications.

REACH & RoHS Compliance

The Luminus 5050 Mid Power LED is compliant to the Restriction of Hazardous Substances Directive or RoHS. The restricted materials including lead, mercury cadmium hexavalent chromium, polybrominated biphenyls (PBB) and polybrominated diphenyl ether (PBDE) are not used.

Understanding Luminus Mid Power LED Test Specifications

Every Luminus LED is fully tested to ensure it meets the high quality standards customers have come to expect from Luminus products.

Testing Temperature

Luminus Mid Power products are measured at a case solder point temperature of 25°C and placed into intensity, chromaticity and voltage bins as described here in

Product Selection Table

Test condition $I_f = 640$, $T_s = 25$ °C

Nominal CCT	Minimum CRI	Ordering Part Number	Minimum Flux (Lumens)	Typical Flux (Lumens)
2700K	70	MP-5050-240H-27-70	560	630
	80	MP-5050-240H-27-80	560	605
	90	MP-5050-240H-27-90	480	515
3000K	70	MP-5050-240H-30-70	600	660
	80	MP-5050-240H-30-80	560	630
	90	MP-5050-240H-30-90	480	535
4000K	70	MP-5050-240H-40-70	600	685
	80	MP-5050-240H-40-80	600	660
	90	MP-5050-240H-40-90	520	565
5000K	70	MP-5050-240H-50-70	600	685
	80	MP-5050-240H-50-80	600	660
	90	MP-5050-240H-50-90	520	565
5700K	70	MP-5050-240H-57-70	600	685
	80	MP-5050-240H-57-80	600	660
	90	MP-5050-240H-57-90	520	565
6500K	70	MP-5050-240H-65-70	600	685
	80	MP-5050-240H-65-80	600	660
	90	MP-5050-240H-65-90	520	565

*IFP condition with Pulse: Width $\leq 100\mu s$ Duty cycle $\leq 1/10$

*Tolerance of measurements of the Luminous Flux is $\pm 7\%$

*Ra measurement tolerance is ± 2

*Correlated Color Temperature is derived from the CIE 1931 Chromaticity diagram

5050 Mid Power Operating Characteristics

Optical and Electrical Characteristics($T_s=25^{\circ}\text{C}$)

Parameter	Symbol	Minimum	Typical	Maximum	Unit	Condition
Forward Voltage	V_f	5.8	6.2	6.6	V	$I_f=640\text{mA}$
Reverse Current	I_r			10	μA	$V_r=5\text{V}$
View Angle	$2\theta^{1/2}$		120		$^{\circ}$	$I_f=640\text{mA}$
Thermal Resistance	R_{th}_{j-sp}		2.5		$^{\circ}\text{C}/\text{W}$	$I_f=640\text{mA}$
Electrostatic Discharge	ESD	1000			V	

Note 1: To prevent damage refer to operating conditions and derating curves for appropriate maximum operating conditions

Note 2: Maximum operating case temperature combined with maximum drive current defines the total maximum operating condition for the device. To prevent damage, please follow derating curves for all operating conditions.

Note 3: Mid power LEDs are designed for operation up to an absolute maximum forward drive current as specified above. Product lifetime data is specified at typical forward drive currents. Sustained operation at absolute maximum currents will result in a reduction of device lifetime compared to typical forward drive currents. Actual device lifetimes will also depend on case temperature. Refer to the current vs. case temperature derating curves for further information.

Note 4: Caution must be taken not to stare at the light emitted from these LEDs. Under special circumstances, the high intensity could damage the eye.

Absolute Maximum Ratings ($T_s=25^{\circ}\text{C}$)

Parameter	Symbol	Rating	Unit
Forward Current	I_f	800	mA
Pulse Forward Current	I_{fp}	1000	mA
Power Dissipation	P_d	5280	mW
Reverse Voltage	V_r	5	V
Operating Temperature	T_{opr}	-40~+105	$^{\circ}\text{C}$
Storage Temperature	T_{sta}	-40~+85	$^{\circ}\text{C}$
Junction Temperature	T_j	120	$^{\circ}\text{C}$
Soldering Temperature	T_{sld}	230 $^{\circ}\text{C}$ or 260 $^{\circ}\text{C}$ for 10 sec	

*IFP condition with Pulse: Width $\leq 100\mu\text{s}$ Duty cycle $\leq 1/10$

Chromaticity Diagram

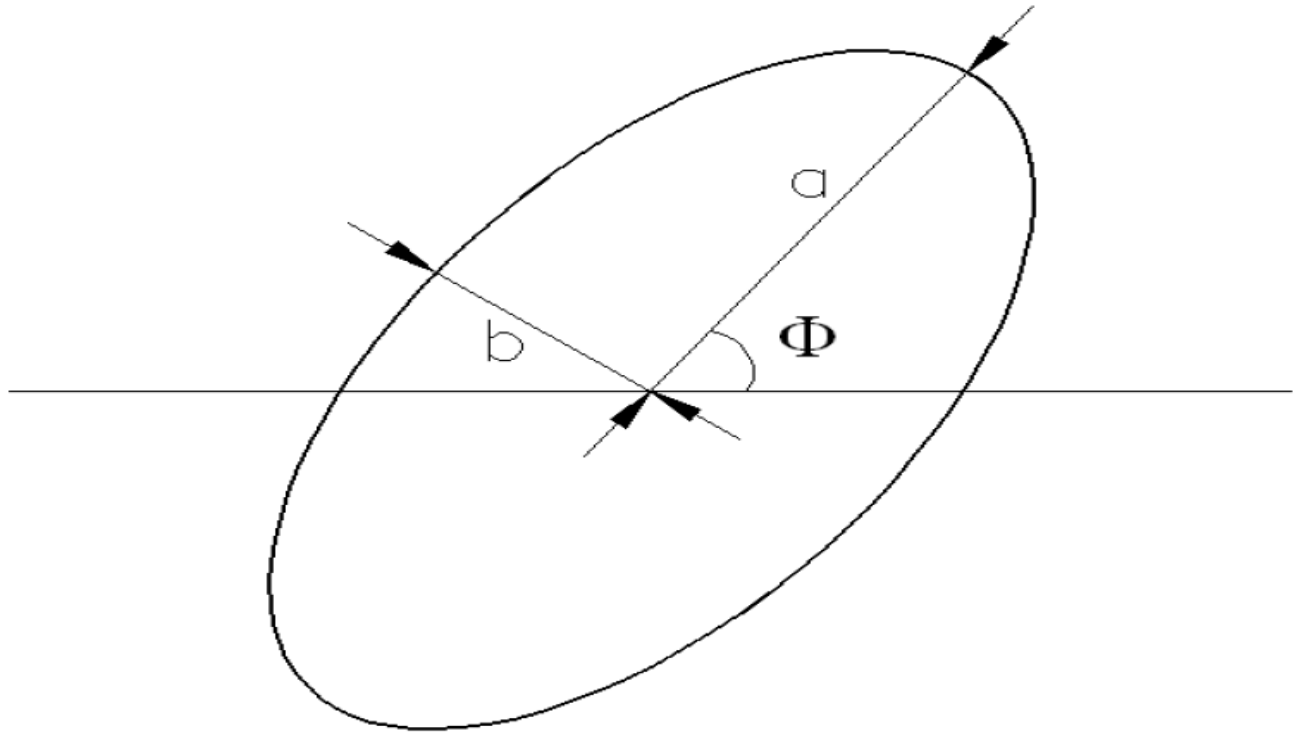

Color Bins

Color Code	Center		Radius		Angle(deg)
	x	y	a	b	
27m5	0.4582	0.4099	0.0135	0.007	53.42
30m5	0.4342	0.4028	0.0139	0.0068	53.13
40m5	0.3825	0.3798	0.01565	0.0067	53.43
50m5	0.3451	0.3554	0.0137	0.0059	59.37
57m5	0.329	0.3417	0.011175	0.0055	58.35
65m5	0.313	0.329	0.01115	0.00475	58.34

*Note: Tolerance of measurements of the chromaticity Coordinate is ± 0.005
 Chromaticity coordinates as per ANSI standard.

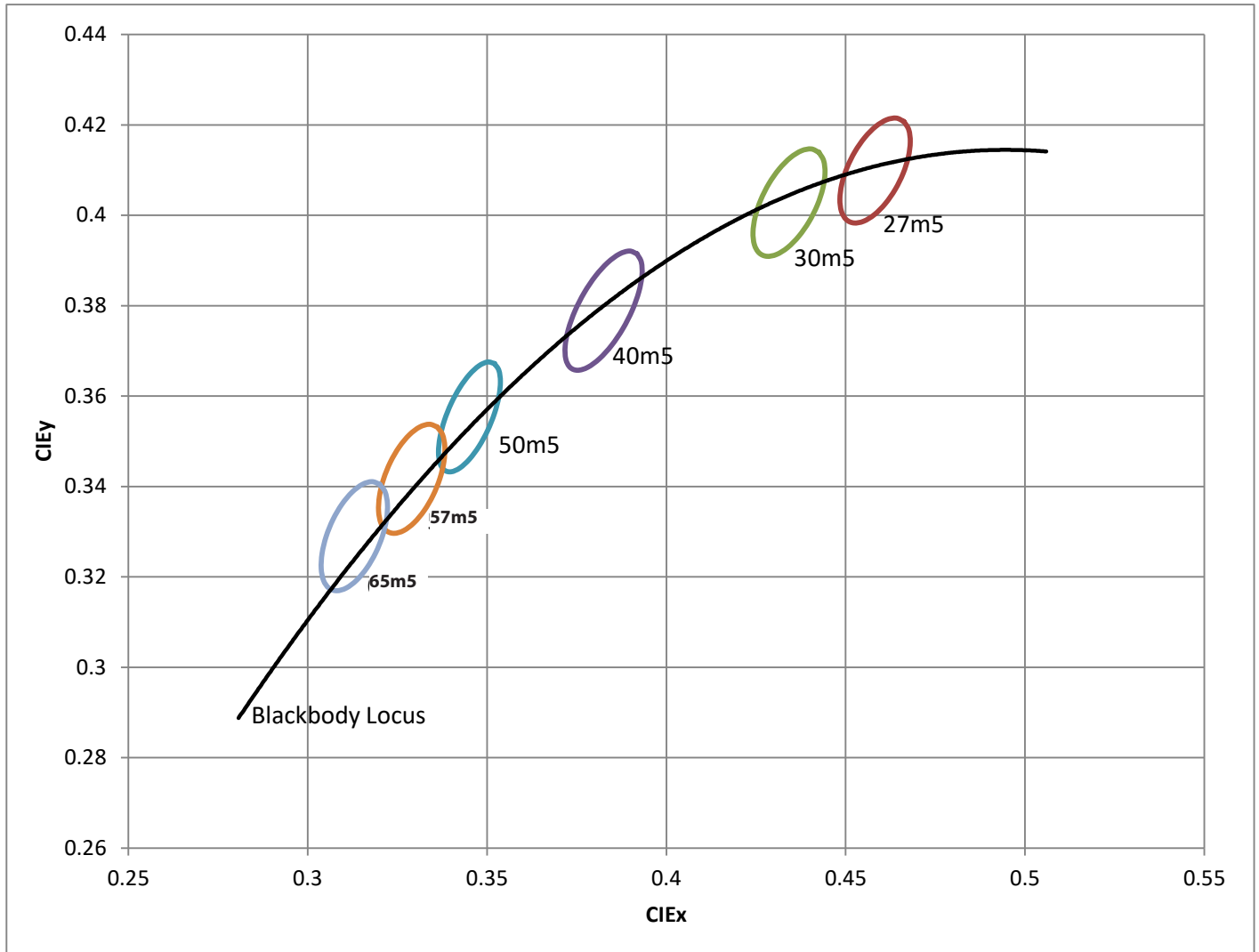
Chromaticity Coordinate Group

*Note: Luminus maintains a +/- 0.01 tolerance on chromaticity (CIEx and CIEy) measurements.

Typical optical/Electrical Characteristics Graphs

I_f ---- Relative Luminous flux

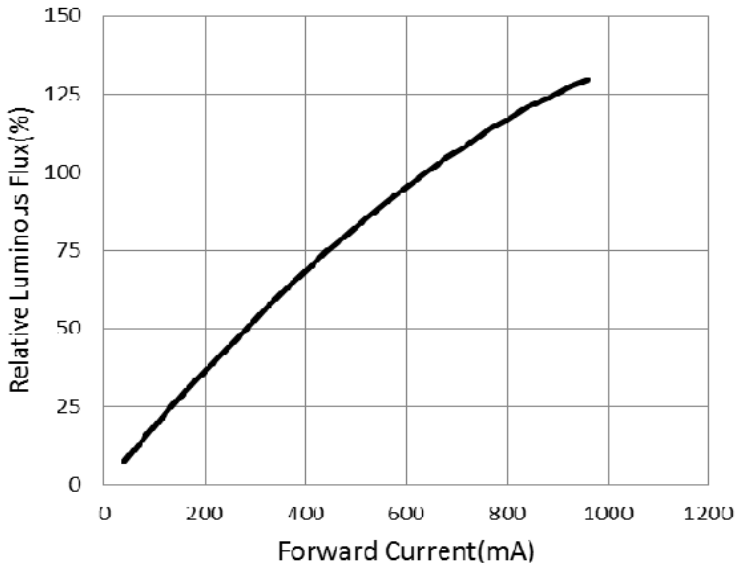

V_f ----- I_f

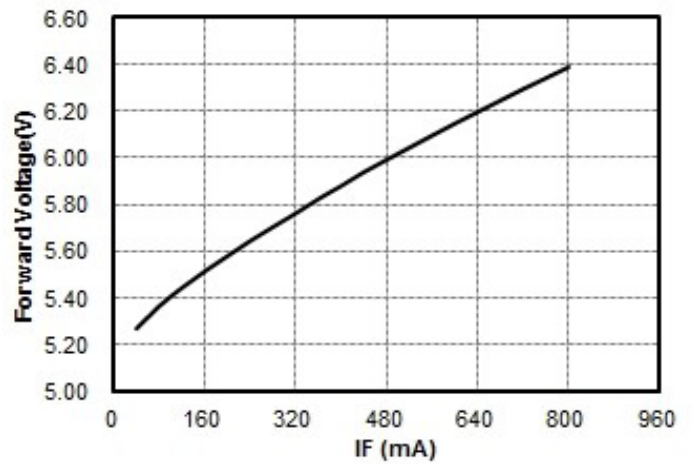

Wavelength- Relative Emission Intensity

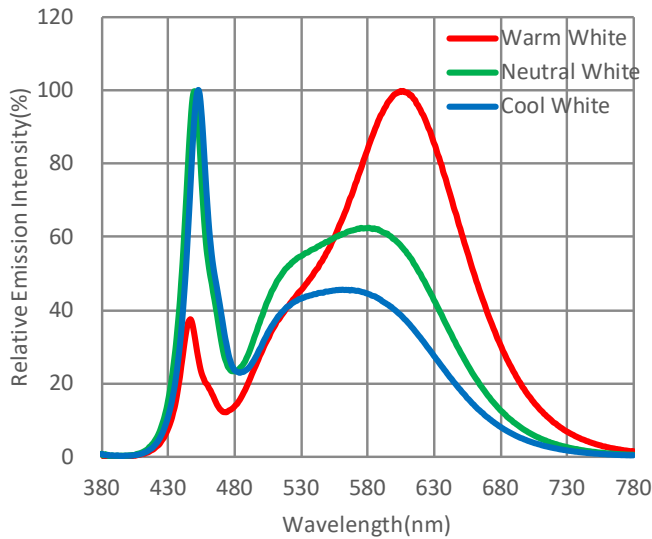

V_f vs. Temperature

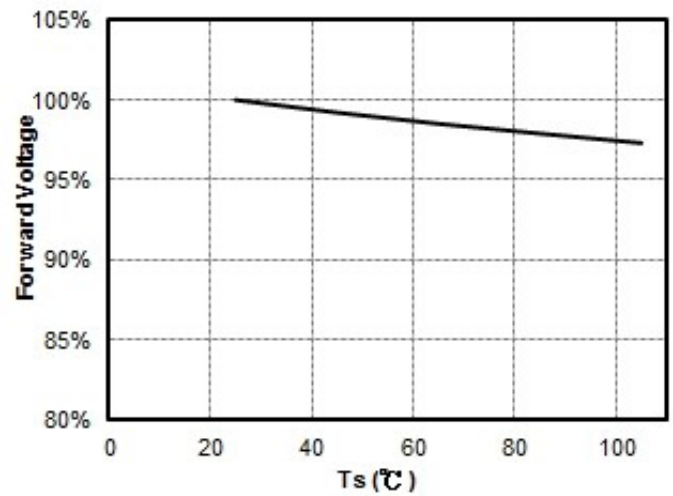

*Note: Luminus maintains a +/- 0.01 tolerance on chromaticity (CIEx and CIEy) measurements.

Typical optical/Electrical Characteristics Graphs

Typical Polar Radiation Pattern

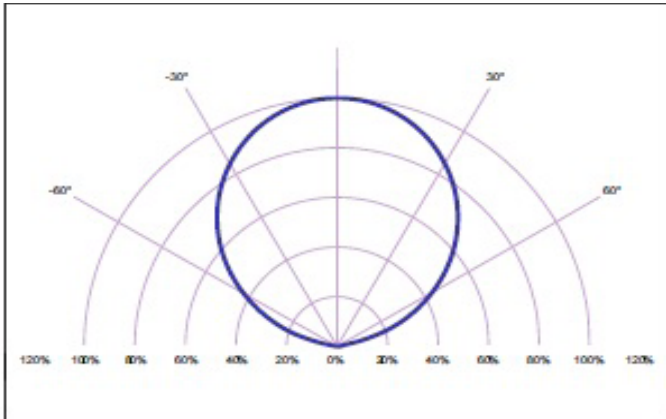

Ambient Temperature- Allowable Forward Current

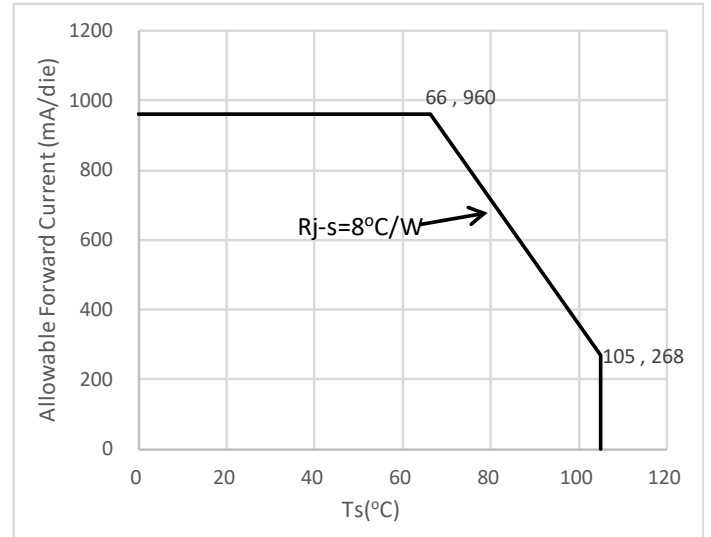

T_s--Relative Luminous flux

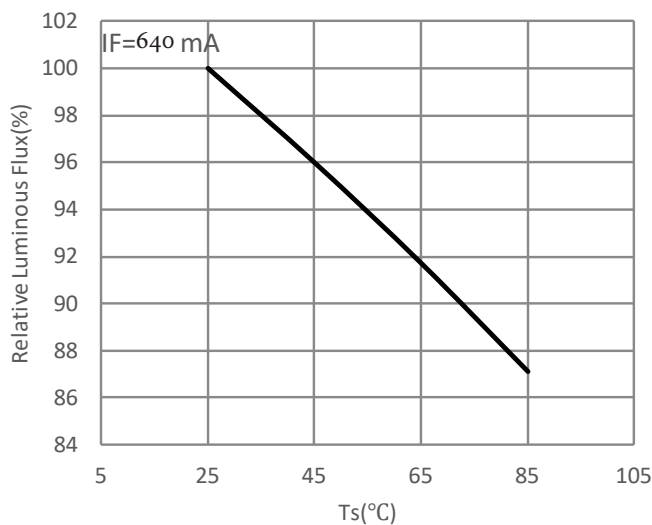

T_s vs. CIE x, y Shift

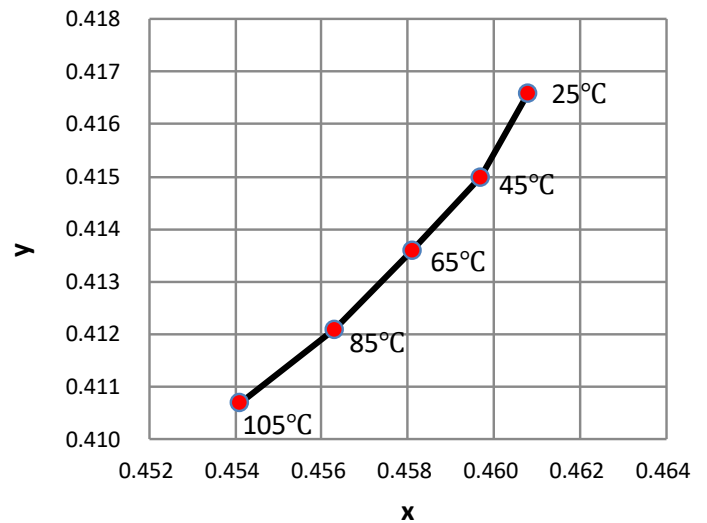

Product Ordering and Shipping Part Number Nomenclature

All mid power products are packaged and labeled with part numbers as outlined in below. When shipped, each reel will contain only a single flux and voltage bin. The part number designation is as follows:

5050 Mid Power LEDs

Mid Power	Package Type	Package Configurator	Nominal CCT	Minimum CRI
MP	5050	240H	##	##

Example:

The part number MP-5050-240H-30-80 refers to a 5050 mid power emitter with nominal color temperature of 3,000k and minimum CRI of 80. Please refer to page 5 for a description of available CCT and CRI combinations.

Note 1: CCT Codes:

27 = 2700 k
30 = 3000 k
40 = 4000 k
50 = 5000 k
57 = 5700 k
65 = 6500 k

Note 2: CRI Codes:

70
80
90

Each mid power product shipped will be labeled with its specific flux and voltage bins. Not all bins listed are available in all CCTs and CRIs.

Luminus Flux Bins

Bin Code	Minimum Flux (Lumens)	Maximum Flux (Lumens)
3A	440	480
3B	480	520
3C	520	560
3D	560	600
3E	600	650
3F	650	700
3G	700	800

Forward Voltage Bins (Ts=25°C)

Bin Code	Minimum Voltage (Volts)	Maximum Voltage (Volts)
B4	5.8	6.0
C4	6.0	6.2
D4	6.2	6.4
E4	6.4	6.6

**Tolerance of measurements f the Forward Voltage is ±0.1V*

Package Dimension (mm)

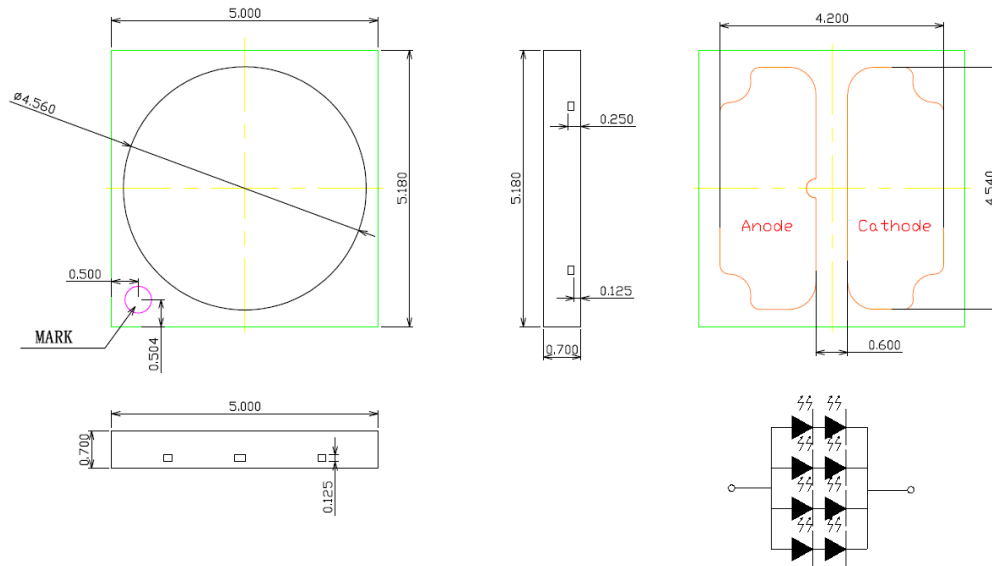

Soldering Pad Pattern and Reflow Soldering Characteristics

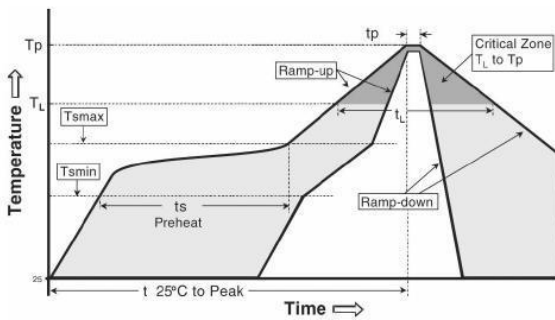
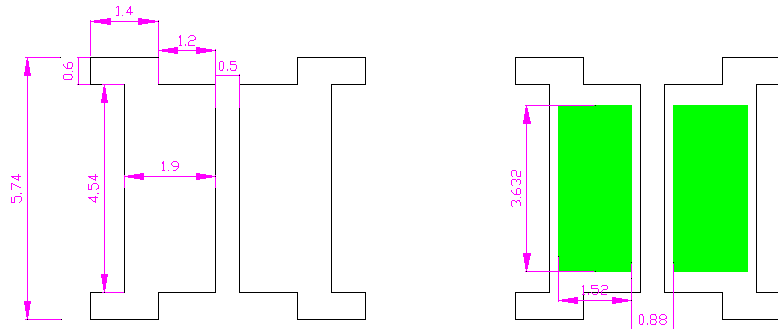

Profile Feature	Spec
Temperature min (T_{smin})	150 °C
Temperature max (T_{smax})	200 °C
Time (T_{smin} to T_{smax}) (t_s)	60 - 120 seconds
Average ramp-up rate (T_{smax} to T_p)	3°C / Second Max
Liquidous temperature (T_L)	217 °C
Time at liquidous (t_L)	60 - 150 seconds
Peak package body temperature (T_p)*	260°C Max
Time (t_p) within 5 °C of the specified classification temperature (T_c)	30 Seconds Max
Average ramp-down rate (T_p to T_{smax})	6°C / Second Max
Time 25 °C to peak temperature	8 Min Max

Package Dimensions Of Type(mm)

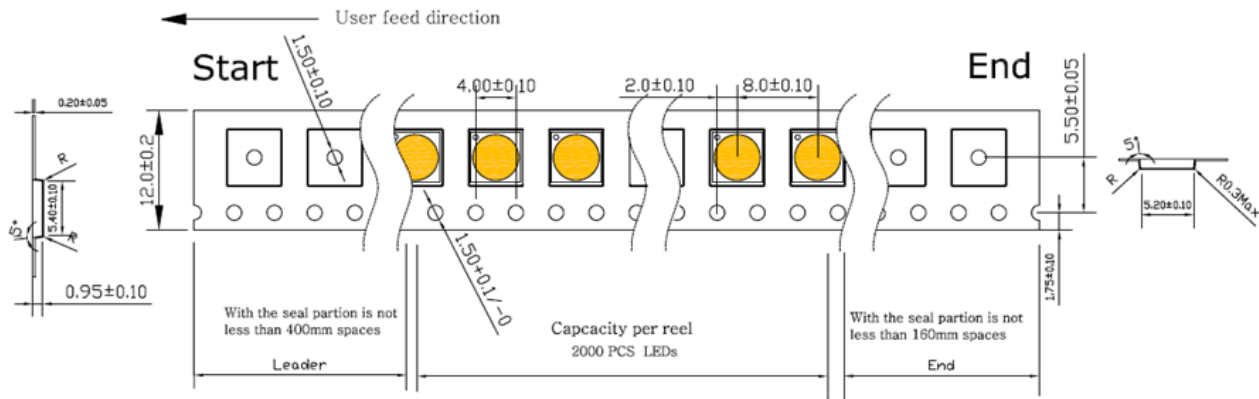

*Quantity : Max 2000pcs/Reel

*Cumulative Tolerance : Cumulative Tolerance/10 pitches to be ±0.2mm

*Adhesion Strength of Cover Tape Adhesion strength to be 0.1-0.7N when the cover tape is turned off from the carrier tape at the angle of 10° to the carrier tape.

*Package : P/N, Manufacturing data Code No. and Quantity to be indicated on a damp proof Package

Label



(1)CPN: MP-*****

(2)Rev:01
Bin Code

(3)Flux: ** (6)Min CRI:**

(4)Voltage:** (7)Lot #:*****

(5)Color: **** (8)Qty:**** RoHS Compliant

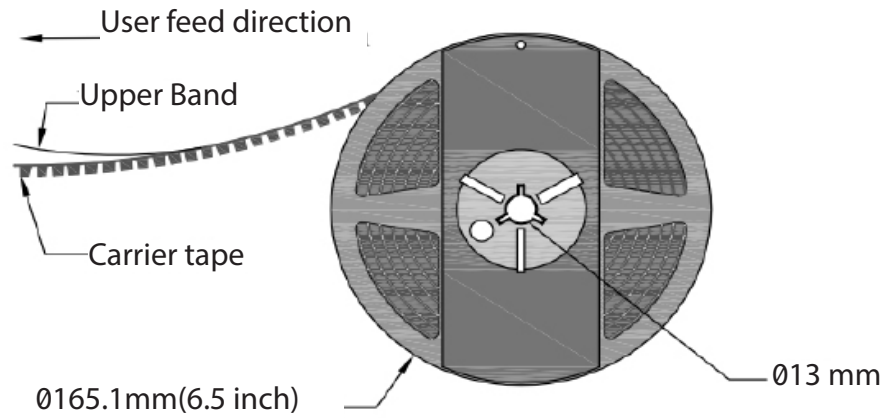
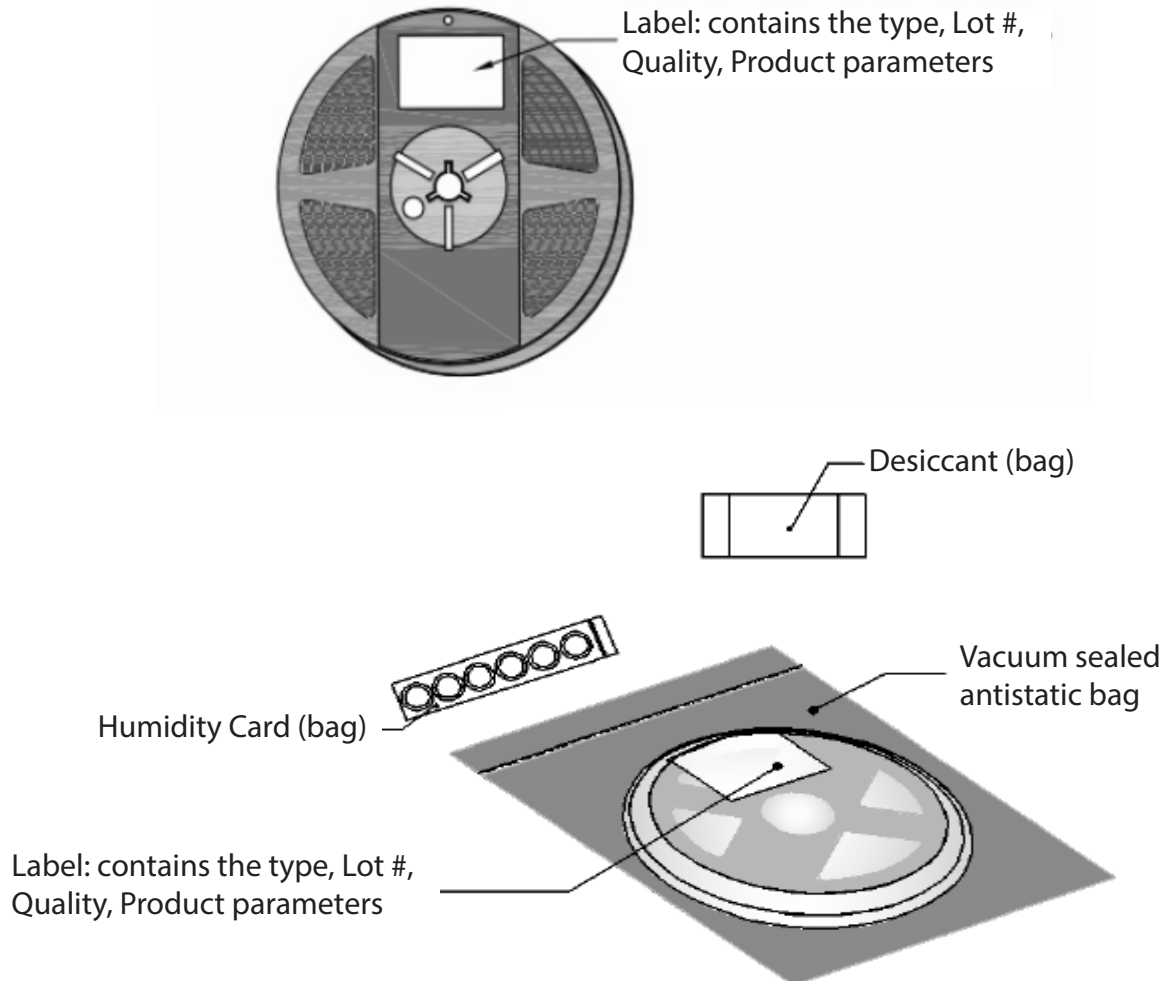

Package Dimensions of Reel (mm)

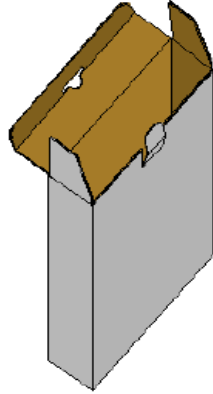
Package Dimensions of Reel (mm)

Inner Box

*Capacity 5 reels per box



Label: contains the type,
Lot #, Quality, Product
parameters



*Capacity 10 reels per box



Label: contains the type,
Lot #, Quality, Product
parameters

Precaution for Use

STORAGE

1.1 Before opening the package

The LEDs should be kept at $<40^{\circ}\text{C}$ & $<90\%RH$. The LEDs should be used within a year. When storing the LEDs, moisture proof package with absorbent material (silica gel) is recommended.

1.2 After opening the package

The LEDs should be kept at $\leq 30^{\circ}\text{C}$ & $\leq 60\%RH$. The LEDs should be soldered within 72 hours (3 days) after opening the moisture proof package.

If unused LEDs remain, they should be stored in moisture proof packages, such as sealed containers with moisture proof package within absorbent material (silica gel). It is also recommended to return the unused LEDs to the original moisture proof package and to seal the moisture proof package again.

If the moisture absorbent material (silica gel) vapors or expires the expiration date, baking treatment should be performed by using the following conditions : 60°C for 20 hours.

The LEDs electrode and leadframe comprise a silver plated copper alloy. The silver surface may be affected by environments. Please avoid conditions which may cause the LEDs being corroded or discolored. The corrosion or discoloration might lower solderability or affect optical characteristics.

Please avoid rapid transition in ambient temperature, especially in high humidity environments where condensation can occur.

STATIC ELECTRICITY

The products are sensitive to static electricity and highly taken care when handling them.

Static electricity or surge voltage will damage the LEDs. It is recommended to wear an anti-electrostatic wristband or an anti-electrostatic glove when handling the LEDs.

All devices, equipment and machinery must be properly grounded. It is recommended that measures be taken against surge voltage to the equipment that mounts the LEDs.